



KEI
Wires & Cables

THE POWER BEHIND THE POWER

EXTRA HIGH VOLTAGE CABLES



THE POWER BEHIND THE POWER

Nature abounds in power of every kind, for every purpose. The wind energy, the solar energy or the electrical energy, clasped in the air around us, all waiting to be harnessed. To be controlled. Only a few especially skilled humans can find specific means to tame these natural resources or replicate them with perfection, for specific and general good. These are the specialists, who with the sheer power of their minds lend brilliance to millions of lives.

 **CABLEGRID**®

P:

E:

W:

KEI
Wires & Cables

THE SPECIALIST

KEI. The wires and cables specialist is ever finding new ways to brighten up the world around. Making electrical energy easily, economically and most importantly adequately available to people and organizations. Like a magician, KEI comes up with products that harness and transport electrical power smoothly in requisite amounts wherever and whenever needed. The specialist in turn empowers millions of households, thousands of industries and the nation on the whole. KEI is thus the specialist who is the power behind all the power we see around us.

THE GENESIS

EVOLUTION

1968

Established a partnership firm to manufacture switch board cables for DOT

1992

Partnership firm converted into Public Limited Company

1995

Issued first IPO.
Became a Listed Co.

1997

Added another plant at Bhiwadi for PVC /XLPE- LV Power Cables

2007

- Commenced new project at Chopanki and modernisation/ expansion at Bhiwadi & Silvassa unit
- Received prestigious corporate governance rating

2008

Successfully commissioned 100% EOU at Chopanki for LV Power Cables

2010

- Technical know-how agreement with BRUGG KABEL A.G., Switzerland for EHV cables
- Commercial production of EHV cables up to 220 kV

2011

Certification of ISO 9001:2008, OHSAS 18001:2007, OHSAS 14001:2004

2016

Extended the technical collaboration with M/s Brugg Kabel AG, Switzerland to manufacture EHV cables above 66kV and up to 400kV

2017

New plant for manufacturing Control & Instrumentation cable up to 66 kV at Pathredi.

2018

Added another plant for manufacturing wires & flexible cables at Chinchpada

2019

Proud recipient of Superbrand Award

THE COMPANY

KEI has been at the forefront of India's wire and cable industry for more than 5 decades. We manufacture a range of specialized cables and are important players in the domestic and retail segment. Our unblemished track record has earned us the patronage of leading industrial houses, project consultants and architects. In order to provide reliable and expedient services to our customers, we have created manufacturing facilities at Silvassa, Chopanki, Bhiwadi and Pathredi. Today, KEI is a one-stop-shop when it comes to meeting cabling requirements for the domestic, power and industrial sectors. KEI has earned a formidable reputation by nurturing relationships, ensuring timely execution of orders and becoming a reliable partner in executing client projects. Our uncompromised cost-effective quality and reliable product range that meets rigorous technical requirements of our customers has made us an undisputed industry leader.

An ISO 9001:2015 certified company; KEI carries out stringent quality control measures under surveillance of a competent team of technocrats and quality enablers. Continuous product innovations and cutting-edge R&D at KEI's in-house labs are what contribute towards constant evolution in our offerings and services. All KEI wires and cables are of a superior quality, a reason why they have been accredited and certified by testing agencies across the globe.



THE ALLIANCE

TWO CABLE GIANTS ONE POWER PACKED FUTURE.

KEI has joined hands with M/s Brugg Kabel AG, a 110 year old Swiss cable giant to upgrade its technology and to manufacture EHV Cables up to 400kV. With this powerful collaboration, the wires and cables specialist is all set to empower many more Indian lives.

It is a KEI initiative that will take the Indian power industry to the next level. So come connect with KEI, connect with success.



THE OVERVIEW

01 ENVIRONMENTAL AND
RELIABILITY ASPECTS
HIGH STANDARDS

03 EHV CABLE SPECIFICATIONS
- Manufacturing Process
- CCV Lline
- Integrated optical fibre unit
- Standard specifications
- Popular constructions



10 CONTINUOUS CURRENT
CARRYING CAPACITY
PRESUMPTIONS
CONTINUOUS CURRENT RATINGS



17 RATINGS
FACTORS

19 MAXIMUM PERMISSIBLE
SHORT-CIRCUIT CURRENTS
FOR CONDUCTOR

22 CABLE LAYOUT AND
SYSTEM DESIGN

24 LAYING
INFORMATION

26 SCREEN BONDING
METHODS

28 TESTING PROCEDURE
AFTER INSTALLATION

33 CABLE ACCESSORIES
JOINTS
TERMINATION

ENVIRONMENTAL AND RELIABILITY ASPECTS

KEI abides by the rules and regulations of the Government and stays in-sync with the public opinion. Similarly, it keeps the environment as its first consideration while planning a new supply route. For instance, it uses the impeccable XLPE system which is an invisible system. It requires a very small area for installation and normally the land can be reused for its original purpose after the installation, resulting in considerable savings. Moreover, reducing the electrical and magnetic fields is also becoming important now-a-days. The cable systems are designed according to different magnetic field requirements and the external electrical fields are zero. With fewer accidental contacts or flashovers, these systems ensure better standards of safety to both workers and general public. Reliability of the network is also an important factor because the loss of supply results in high cost consequences. The EHV cable systems are less vulnerable to failures compared to the overhead lines.

HIGH STANDARDS

Partial discharge in the cables insulation is one of the main reasons for electrical breakdowns. Most of the recognized national and international standards permit discharges of max. 5 pC. However, our policy is not to allow deliveries of cables with any detectable discharges.



EHV CABLE SPECIFICATION



Scope

This specification applies to materials and constructions of cross-linked thermosetting polyethylene (XLPE) insulated cables for extra high voltage transmission of rated voltage from 66kV grade up to and including 400 kV grade. This specification deals manufacturer's standard models of the cable, however any other customised cable design as per project & customer requirements.

Conductor

The conductor shall be formed from copper or aluminium complying with various international or national standard. The conductor shall be stranded circular, compacted circular, or segmental compacted circular. Segmental compacted circular conductors shall be applied to cables of conductor nominal cross-sectional areas of 1000 mm² and above.

Conductor Shielding

Conductor shielding of an extruded semi-conducting thermosetting compound shall be applied over the conductor. One or two layer of semi-conducting tape(s) may be applied with an proper lapping between the conductor and the extruded semi-conducting layer.

Insulation

The insulation shall be of dry-cured XLPE compound with a thickness to meet dimensional, electrical and physical requirements specified. The compound shall be high quality, heat-, moisture-, ozone- and corona resistant. This insulation shall be suitable for operation in wet or dry locations at conductor temperature not exceeding 90°C for normal condition, 130°C for emergency overload conditions and 250°C for short circuit conditions.



Insulation Shielding

The insulation shielding shall be applied direct upon the Insulation and shall consist of a layer of extruded semi-conducting compound. The extruded semiconducting compound shall be a thermosetting compound and firmly and totally bonded to the insulation.

Metallic Layer

The metallic layer can be applied over the insulation shielding to reinforce the capability of carrying fault current specified, if required. The metallic layer will be one of the them as describe in popular construction.

Inner Bedding

If required, extruded layer of a thermoplastic compound, PVC or PE can be applied.

Metal Tape Moisture Barrier

When the moisture barrier required, a layer of aluminium tape laminated at both or outer side with copolymer shall be applied longitudinally over the cable core with an overlap so as to lapped parts of the tape on each other.

Or, a corrugated aluminium sheath / copper sheath / stainless steel sheath or lead alloy sheath is adopted with bituminous compound primer shall be applied over the metallic sheath to protect the sheath against local corrosion.

Outer Jacket

The outer jacket shall consist of thermoplastic compound (PVC, PE or similar materials) extruded continuously over the metallic layer or moisture barrier followed by semiconducting layer.

MANUFACTURING PROCESS FLOW CHART

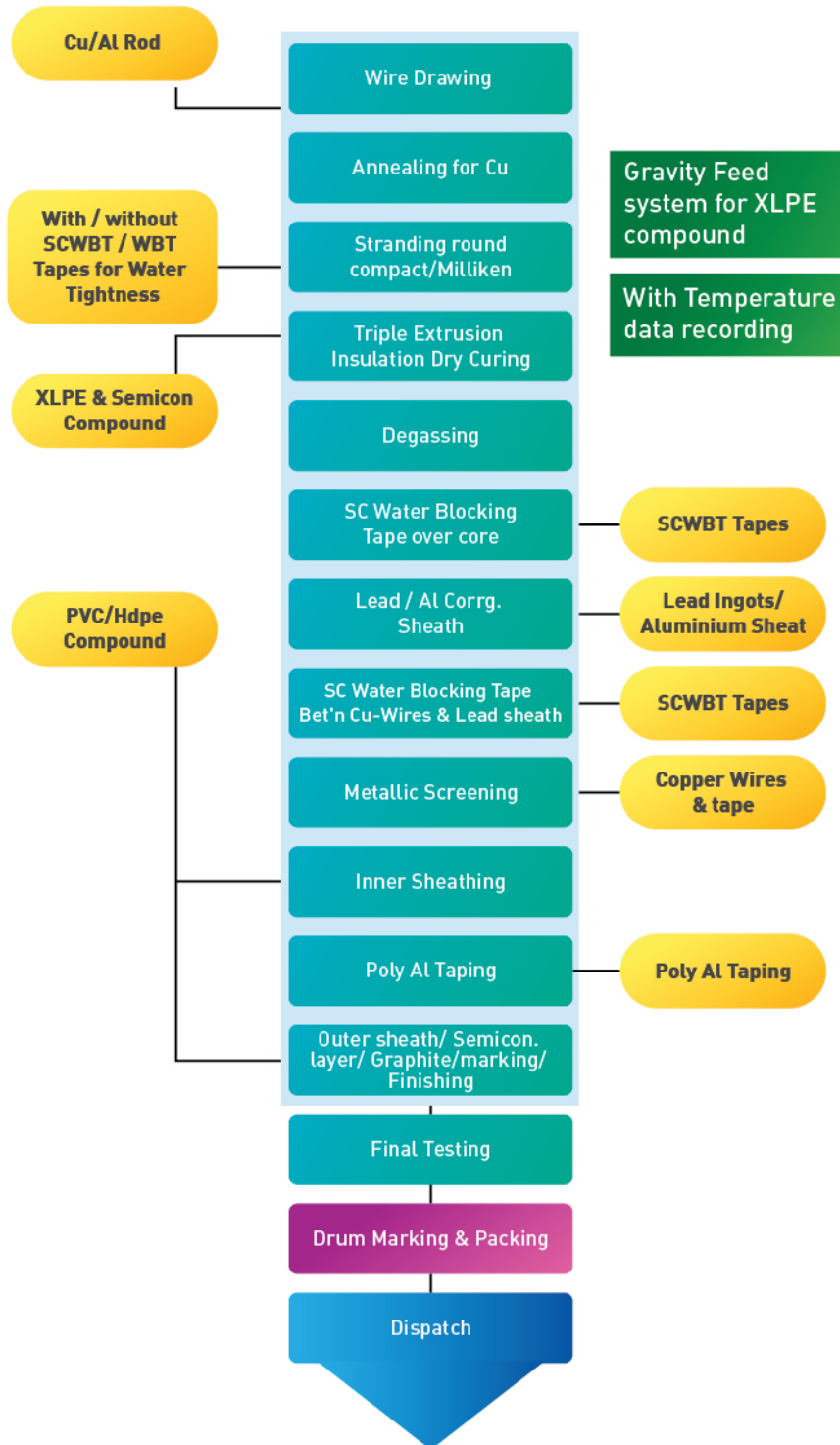

- RAW MATERIAL INPUT
- FINISHED GOODS INSPECTION
- PROCESS
- PROCESS & INSPECTION
- DESPATCH

- Resistivity, Wire diameter, Tensile strength, Wrapping Test & Surface finish
- Resistivity, Anealing, Wire diameter, Surface finish
- No. of strands, Conductor diameter, Segmentdimentions, Tapes Thickness, Conductor Resistance , Suface finish
- Thickness, Hot Set, Diameter, Eccentricity, Ovality, Silicon Dip Test for void & contamitnation check, Tensile Strength & Elongation, Wafer Boil Test, Surface Finish.
- Temperature, Duration,Silicon Dip Test for voids check
- Tape Thickness, No of Tapes, Diameter
- Thickness, Diameter over sheath, Corrugation Type, Surface Finish
- Tape Thickness, No of Tapes, Overlap
- Wire Diameter, No. of Wires, Tape Thickness & Nos. , Built up Diameter, Surface Finish
- Material, Thickness, Diame-ter, Suface Finish,
- Thickness, Adhesion, Peel of Strength, Diameter, Surface Finish.
- Thickness, Conductive layer finish, Sequential Marking, Empty Drums Size & Hard ware Check, Rewinding, Suface Finish, Overall Diame-ter.
- Routine Test on 100% Drums, Type Test/Size/Voltage Grade, Surface Finish, mtr. Marking & Embassing Check.
- Ends Cutting & Capping, Ends Securing, Stencil on Drums, Packing of Cable drums with PE Sheet & Wooden Laggings /GI Sheet
- Drum support pallet Shall be used if drum is heavy or Large size drums (↑ 10 Tonnes, L 3000mm x W 1800mm)

Continuous Catenary Vulcanization (CCV) LINES

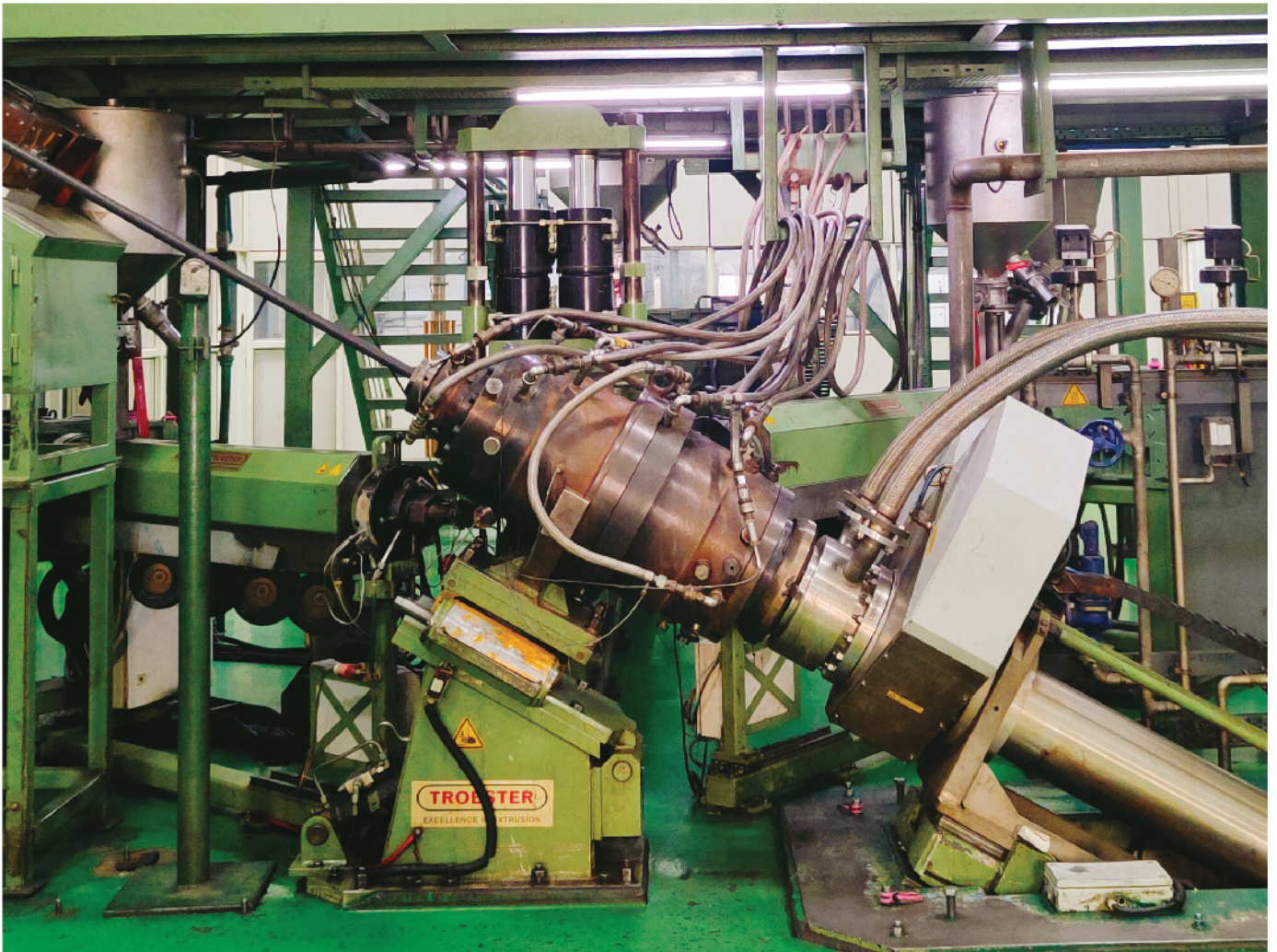

The system adopted for insulation of EHV cable is Continuous Catenary Vulcanization (CCV) lines with Twin-Rot rotating caterpillar and there are included with triple extrusion along with Dry Curing and Dry cooling system with Nitrogen as medium, having eccentricity, ovality & diameter online X-Ray monitoring system (Sikora Make).

The outstanding characteristics of the cable manufactured in application of the system are:

1. Perfect concentricity and roundness through TWINROT and TROSS Technology.
2. Perfect dry curing system (N₂ gas) through CCV line.
3. High Production Speeds by High Output Concept.
4. Uniformity of quality is maintained of all products as the manufacturing processes are controlled by computer.
5. Environment Friendly: Gas filtering system, by product collection , low energy heating.
6. Excellent cleanness achieved by closed material handling system gravimetric method.
7. Perfect Quality assurance of the EHV cable production.

INTEGRATED OPTICAL FIBRE UNIT

The optical fibres in power cables can be used for measuring the actual temperature along with the cable line or for data transmission. Fibre units are normally embedded under the lead sheath or between the screen wires. The temperature monitoring provides continuous monitoring of cable temperatures, detecting hot spots, delivering operational status, condition assessments and power circuit rating data. Ideal for use in high voltage cables, it provides reliable temperature measurements and is immune to electromagnetic interference.

STANDARD SPECIFICATIONS

KEI manufactures Extra High Voltage cables according to various international or national standards. Such as, IEC: 60840, IEC: 62067, IS: 7098 (P-3)/93, AN/NZS 1429.2-2009. Cable are also designed specially to the customer's requirement.

POPULAR CONSTRUCTIONS

(A) Single Core XLPE insulated power cable with Seam Welded Smooth Aluminium Sheath



1. Conductor : Longitudinally watertight - stranded compacted circular / Milliken Copper or Aluminium
2. Binder Tapes: Semiconducting water blocking tape
3. Conductor Screen : Extruded semiconducting compound
4. Insulation : Extruded super clean XLPE Compound
5. Insulation Screen : Extruded semiconducting compound
6. Bedding : Semi conducting water swellable tape and Semi conducting water swellable Foam tape
7. Metallic Sheath : Seam Welded Smooth Aluminium Sheath
8. Outer Sheath : Extruded PE Sheath + Extruded HDPE sheath with extruded Semiconducting layer/ Graphite Coating

*We Manufacture Milliken conductor for sizes 800 mm² and above on request.

(B) Single Core XLPE insulated power cable with Seam welded Corrugated Aluminium Sheath



1. Conductor : Longitudinally watertight - stranded compacted circular / Milliken Copper or Aluminium
2. Binder Tapes: Semiconducting water blocking tape
3. Conductor Screen : Extruded semiconducting compound
4. Insulation : Extruded super clean XLPE Compound
5. Insulation Screen : Extruded semiconducting compound
6. Bedding : Semi conducting water swellable tape and Semi conducting water swellable Foam tape
7. Metallic Sheath : Seam welded Corrugated Aluminium Sheath
8. Anticorrosion layer: Bitumen layer followed by bituminized cotton tape
9. Outer Sheath : Extruded HDPE / PVC / HFFR sheath followed by a Semi Conducting layer/ Graphite Coating

*We Manufacture Milliken conductor for sizes 800 mm² and above on request.

(C) Single Core XLPE insulated power cable with Copper wire screen and foil laminated sheath

1. Conductor : Longitudinally watertight - stranded compacted circular / Milliken Copper or Aluminium
2. Binder Tapes: Semiconducting water blocking tape
3. Conductor Screen : Extruded semiconducting compound
4. Insulation : Extruded super clean XLPE Compound
5. Insulation Screen : Extruded semiconducting compound
6. Bedding : Semi conducting water swellable tape
7. Metallic Sheath : A layer of copper wire helix and a copper contact tape in open helix
8. Separation Tapes: Semi conducting water swellable tape
9. Radial Water Barrier: Aluminium or Copper foil laminate
10. Outer Sheath : Extruded PE / HFFR sheath followed by a Semi Conducting layer / Graphite Coating



*We Manufacture Milliken conductor for sizes 800 mm² and above on request.

(D) Single Core XLPE insulated power cable with Copper wire screen (if required) and Lead sheath



1. Conductor : Longitudinally watertight - stranded compacted circular / Milliken Copper or Aluminium
2. Binder Tapes: Semiconducting water blocking tape
3. Conductor Screen : Extruded semiconducting compound
4. Insulation : Extruded super clean XLPE compound
5. Insulation Screen : Extruded semiconducting compound
6. Bedding : Semi conducting water swellable tape
7. Metallic Sheath : A layer of copper wire helix and a copper contact tape in open helix (If required)
8. Separation Tapes: Semi conducting water swellable tape
9. Metallic Sheath: Extruded Lead sheath
10. Outer Sheath : Extruded HDPE / PVC / HFFR sheath followed by a Semi Conducting layer followed by a Semi Conducting layer/ Graphite Coating

*We Manufacture Milliken conductor for sizes 800 mm² and above on request.

(E) Single Core XLPE insulated power cable with Seam welded Corrugated Stainless steel Sheath

1. Conductor : Longitudinally watertight - stranded compacted circular / Milliken Copper or Aluminium
2. Binder Tapes: Semiconducting water blocking tapes compound
3. Conductor Screen : Extruded semiconducting copolymer compound
4. Insulation : Extruded super clean XLPE Compound
5. Insulation Screen : Extruded semiconducting copolymer compound
6. Bedding : Semi conducting water swellable tape
7. Metallic Sheath : Plain annealed round Copper wire Screen with copper tape in open helix
8. Separation Tapes: Semi conducting water swellable tape
9. Separation Tapes : Semi conducting water swellable Foam tape and Copper Woven Semiconducting WS Tape
10. Metallic Sheath : Seam welded Corrugated Stainless steel Sheath
11. Anticorrrosion layer: Bitumen layer followed by bituminized cotton tape
12. Outer Sheath : Extruded HDPE, PVC or HFFR Compound followed by a Semi Conducting layer/ Graphite Coating



(F) Single Core XLPE insulated power cable with Seam welded Corrugated Copper Sheath



1. Conductor : Longitudinally watertight - stranded compacted circular / Milliken Copper or Aluminium
2. Binder Tapes: Semiconducting water blocking tapes compound
3. Conductor Screen : Extruded semiconducting copolymer compound
4. Insulation : Extruded super clean XLPE Compound
5. Insulation Screen : Extruded semiconducting copolymer compound
6. Bedding : Semi conducting water swellable tape and Semi conducting water swellable Foam tape
7. Metallic Sheath : Seam welded Corrugated Copper Sheath
8. Separation Tapes: Bitumen layer followed by bituminized cotton tape
9. Radial Water Barrier: Extruded HDPE, PVC or HFFR Compound followed by a Semi Conducting layer/ Graphite Coating

The cable construction described above are our standard construction. However, we can manufacture cable as per customer's requirement, such as armoured cable or cable with composite outer sheath for termite protection.



The electrical properties and continuous current rating apply for Lead sheathed cable with our normal sheath thickness. The thickness of sheath and especially the cross-section of Copper screen can be adjusted according to required short-circuit rating of sheath or screen.

Where loading is cyclic, appreciable increase in current capacities may be justified. Refer to IEC publication 60853 for calculation of the cyclic ratings. In cable circuits having no magnetic saturating materials the positive and negative sequence impedances are equal and can be deduced from the tabulated effective resistance and inductance values corrected as required for frequencies other than 50 Hz.

Zero sequence impedance for solidly bonded systems can be roughly estimated as the sum of the resistances of conductor, sheath and a reactance of 0.05 to 0.1 ohms/km depending on the proportion of diameters of sheath and conductor at 50 to 60 Hz. For single point bonded systems, the zero sequence, impedance depends on the ground wires and any other grounded metallic objects along the cable route.

SELECTING A POWER CABLE

Different kinds of power cable construction are required to transport electrical energy from the power station to the consumer. The following factors are important when selecting a suitable cable construction:

- Maximum operating voltage
- Insulation level frequency
- Load to be carried
- Daily load curve
- Magnitude and duration of possible overloads currents phase-to-phase and phase-to -earth
- Connection between overhead and cable line (whether directly or via a transformer)
- Insulation level of equipment (bare conductor insulators, arresters, etc.)
- Voltage drop
- Length of line
- Profile of line
- Mode of installation
 - Underground (whether directly or in ducts)
 - In air (if in a tunnel, the dimensions and mode of ventilation of tunnel)
- Chemical and physical properties of the soil
 - Whether rocky, sandy, clay or boggy, moist or dry
 - Chemical agents liable to cause corrosion
 - The maximum thermal resistivity of the soil
- Maximum and minimum ambient air and soil temperatures, bearing in mind nearby hot water pipes and other factors liable to heat the cables.
- Specifications and requirements to be met. The cross-sectional area can be calculated based on the capital costs of the cable and its running costs incurred by the power losses in the cable.

RATED VOLTAGE

The voltage which forms the basis for certain operating characteristics and test conditions is called the rated voltage and test conditions is called the rated voltages and is denoted U_0/U where

U_0 = The voltage between the conductor and earth or earthed metallic cover (Concentric conductor, screen, armoring, metal sheath)

U = The voltage between the phase conductors



Aluminium Corrugation Sheathing Line

OPERATING VOLTAGE

Um = The maximum continuously permissible operating voltage of the network at any time or any part of the network, excluding temporary fluctuations such as those occurring during switching or faults The relationship between U₀/U and Um in three phase systems according to IEC specification is as follows:

U ₀ /U kV	36/66	64/110	76/132	127/220	190/330	220/400
Um kV	72.5	123	145	245	362	420



CONTINUOUS CURRENT CARRYING CAPACITY

A separate group of three single core cables can be continuously loaded according to the tables on 1.1-1.4 and 2.1-2.4 if the presumptions below are fulfilled. Correction factors for other installations are given in table A to H. The current-carrying capacities are calculated in accordance with the IEC publications 60287 and under the presumptions given below.

PRESUMPTIONS

- One three-phase group of single core cable

Standard conditions for current rating are given below:

- Maximum conductor temperature 90°C
- Ambient air temperature 40°C
- Ground temperature 30°C
- Depth of laying of cables 1.5 m
- Thermal resistivity of soil 150°C - cm /w

Distance between single core cables

- In case of flat formation-300mm spacing
- In case of trefoil formation-cable touching each other
- Thermal resistivity of soil 150°C-Cm/W
- Cable in air-heat dissipation conditions same as cables in free air
- Open screen circuit in single core cable group - circuit of metal sheaths, concentric conductors or metallic screens connected to each other and earthed at one point only - screen bonded at a single point. In addition, screen circuit is considered open when cross-bonded at equal interval
- Closed screen circuit in single core cable group - circuit of metal sheaths, concentric conductors or metallic screens connected to each other at both ends of the group and earthed at least at one end - screens bonded at both ends.

CONTINUOUS CURRENT RATINGS

1.1 38/66KV (E) POLY AL

Conductor Shape	38/66KV (E) POLY AL									Approx. Cable OD (mm)	**Approx. Cable Weight (kg/mtrs)	
	AREA SQMM	Copper(Ground)		Copper(Air)		Aluminium(Ground)		Aluminium(Air)			Copper	Aluminium
		TREFOIL	FLAT	TREFOIL	FLAT	TREFOIL	FLAT	TREFOIL	FLAT			
Stranded Compacted Circular	240	413	471	608	692	324	366	479	541	60	4.29	2.88
	300	464	530	694	793	362	412	541	616	62	4.90	3.14
	400	526	603	802	923	414	471	631	721	65	5.93	3.58
	500	592	684	923	1072	471	537	732	841	68	6.96	4.02
	630	666	776	1060	1245	536	613	851	983	72	8.27	4.57
	800	738	871	1204	1437	603	695	982	1145	76	9.99	5.29
Stranded Segmental milliken overall Compacted Circular	1000	849	986	1427	1678	702	801	1176	1363	86	12.28	6.41
	1200	901	1054	1539	1825	761	872	1291	1503	89	14.18	7.09
	1600	1000	1185	1767	2132	880	1014	1550	1823	98	18.08	8.69
	2000	1067	1283	1927	2361	975	1135	1757	2086	103	21.81	10.07
	2500	1130	1378	2084	2591	1050	1231	1931	2311	109	26.42	11.75

* The above data is indicative, and may vary depending on the client's specification.
 ** Approximate Cable weight is only for transportation guidelines.

1.2 38/66KV (E) LEAD SHEATHED

Conductor Shape	38/66KV (E) LEAD SHEATHED									Approx. Cable OD (mm)	**Approx. Cable Weight (kg/mtrs)	
	AREA SQMM	Copper(Ground)		Copper(Air)		Aluminium(Ground)		Aluminium(Air)			Copper	Aluminium
		TREFOIL	FLAT	TREFOIL	FLAT	TREFOIL	FLAT	TREFOIL	FLAT			
Stranded Compacted Circular	240	416	471	615	697	324	366	479	541	63	9.31	7.91
	300	467	531	702	798	364	412	547	620	65	10.05	8.28
	400	530	603	812	928	417	471	638	725	69	11.49	9.14
	500	599	685	936	1078	475	538	741	846	72	12.92	9.98
	630	675	777	1077	1253	540	614	862	989	76	14.70	11.00
	800	750	873	1226	1444	611	696	996	1151	81	16.95	12.25
Stranded Segmental milliken overall Compacted Circular	1000	862	988	1451	1686	709	802	1192	1369	91	20.19	14.32
	1200	916	1056	1566	1834	770	874	1309	1511	94	22.58	15.42
	1600	1016	1188	1801	2146	891	1017	1574	1835	103	27.80	18.41
	2000	1086	1286	1965	2373	989	1137	1784	2097	109	32.59	20.85
	2500	1151	1380	2126	2605	1064	1233	1961	2324	115	38.05	23.37

* The above data is indicative, and may vary depending on the client's specification.

** Approximate Cable weight is only for transportation guidelines.

1.3 38/66KV (E) CORRUGATED ALUMINIUM SHEATH

Conductor Shape	38/66KV (E) CORRUGATED ALUMINIUM SHEATH									Approx. Cable OD (mm)	**Approx. Cable Weight (kg/mtrs)	
	AREA SQMM	Copper(Ground)		Copper(Air)		Aluminium(Ground)		Aluminium(Air)			Copper	Aluminium
		TREFOIL	FLAT	TREFOIL	FLAT	TREFOIL	FLAT	TREFOIL	FLAT			
Stranded Compacted Circular	240	407	465	598	677	319	362	468	526	68	5.54	4.13
	300	455	524	679	774	358	407	532	601	70	6.22	4.46
	400	514	596	782	898	408	466	618	702	73	7.18	4.84
	500	575	676	895	1040	462	531	714	818	76	8.27	5.34
	630	644	766	1022	1206	523	606	826	954	79	9.52	5.82
	800	708	859	1153	1386	585	686	948	1107	84	11.29	6.60
Stranded Segmental milliken overall Compacted Circular	1000	795	969	1342	1615	670	790	1121	1316	93	13.78	7.91
	1200	836	1034	1436	1750	720	858	1221	1445	96	15.73	8.64
	1600	909	1156	1622	2032	815	994	1441	1745	105	19.80	10.41
	2000	956	1245	1748	2236	887	1107	1610	1985	110	23.62	11.89
	2500	1000	1327	1872	2439	941	1193	1751	2190	116	28.39	13.66

* The above data is indicative, and may vary depending on the client's specification.

** Approximate Cable weight is only for transportation guidelines.

1.4 38/66kV (E) SMOOTH ALUMINIUM SHEATH

Conductor Shape	38/66kV (E) SMOOTH ALUMINIUM SHEATH									Approx. Cable OD (mm)	**Approx. Cable Weight (kg/mtrs)	
	AREA SQMM	Copper(Ground)		Copper(Air)		Aluminium(Ground)		Aluminium(Air)			Copper	Aluminium
		TREFOIL	FLAT	TREFOIL	FLAT	TREFOIL	FLAT	TREFOIL	FLAT			
Stranded Compacted Circular	240	407	467	599	681	319	363	468	529	64	5.397	3.958
	300	455	526	680	779	358	409	533	605	66	6.066	4.267
	400	513	598	783	906	407	467	619	708	69	7.155	4.757
	500	575	678	896	1051	461	533	716	825	72	8.244	5.247
	630	640	769	1022	1219	521	608	828	964	76	9.637	5.860
	800	702	862	1151	1404	582	689	949	1121	80	11.427	6.631
Stranded Segmental Milliken Overall Compacted Circular	1000	787	973	1340	1637	665	793	1122	1333	89	14.136	7.991
	1200	827	1038	1433	1775	714	862	1222	1466	92	16.186	8.721
	1600	895	1160	1615	2063	805	997	1441	1772	101	20.428	10.536
	2000	941	1248	1738	2267	876	1110	1607	2014	106	24.329	12.039
	2500	980	1389	1853	2467	927	1197	1741	2218	112	29.309	13.902

* The above data is indicative, and may vary depending on the client's specification.

** Approximate Cable weight is only for transportation guidelines.

1.5 38/66kV (E) CORRUGATED COPPER SHEATH

Conductor Shape	38/66kV (E) CORRUGATED COPPER SHEATH									Approx. Cable OD (mm)	**Approx. Cable Weight (Kg/mtrs)	
	AREA SQMM	Copper (Ground)		Copper (Air)		Aluminium (Ground)		Aluminium (Air)			Copper	Aluminium
		TREFOIL	FLAT	TREFOIL	FLAT	TREFOIL	FLAT	TREFOIL	FLAT			
Stranded Compacted Circular	240	408	461	592	661	319	358	462	513	75	7.380	5.942
	300	457	755	673	519	358	403	527	587	77	8.058	6.259
	400	516	461	775	877	408	519	612	685	80	9.160	6.762
	500	578	667	884	1004	462	524	704	789	88	10.398	7.400
	630	646	760	1015	1178	524	601	818	931	86	11.538	7.762
	800	712	854	1148	1362	588	682	941	1087	88	13.289	8.493
Stranded Segmental Milliken Overall Compacted Circular	1000	800	966	1337	1592	672	787	1114	1296	96	16.115	9.970
	1200	842	1030	1432	1725	724	856	1220	1433	99	17.963	11.015
	1600	916	1151	1610	1987	819	989	1426	1706	106	22.539	12.647
	2000	967	1241	1746	2200	895	1103	1605	1954	113	26.668	14.378
	2500	1010	1322	1866	2393	949	1190	1743	2151	119	31.760	16.352

* The above data is indicative, and may vary depending on the client's specification.

** Approximate Cable weight is only for transportation guidelines.

1.6 38/66kV (E) CORRUGATED STAINLESS STEEL SHEATH

Conductor Shape	38/66kV (E) CORRUGATED STAINLESS STEEL SHEATH									Approx. Cable OD (mm)	**Approx. Cable Weight (Kg/mtrs)	
	AREA SQMM	Copper (Ground)		Copper (Air)		Aluminium (Ground)		Aluminium (Air)			Copper	Aluminium
		TREFOIL	FLAT	TREFOIL	FLAT	TREFOIL	FLAT	TREFOIL	FLAT			
Stranded Compacted Circular	240	414	461	598	661	322	358	465	513	74	8.128	6.689
	300	466	520	682	756	363	404	530	587	76	8.789	6.991
	400	530	592	789	879	415	462	618	686	79	9.907	7.509
	500	600	672	910	1018	474	528	717	799	82	11.005	8.007
	630	679	763	1048	1181	541	603	834	932	86	12.436	8.660
	800	759	858	1196	1361	613	684	965	1085	90	14.256	9.460
Stranded Segmental Milliken Overall Compacted Circular	1000	876	974	1417	1594	715	791	1157	1294	99	17.031	10.886
	1200	936	1042	1532	1729	779	861	1271	1422	102	19.111	11.578
	1600	1050	1174	1763	2011	909	1003	1527	1716	109	23.279	13.387
	2000	1137	1276	1952	2244	1023	1127	1757	1981	116	27.394	15.104
	2500	1217	1373	2126	2465	1114	1226	1945	2198	122	32.374	16.966

* The above data is indicative, and may vary depending on the client's specification.

** Approximate Cable weight is only for transportation guidelines.

1.7 64/110KV (E) POLY AL

Conductor Shape	64/110KV (E) POLYAL									Approx. Cable OD (mm)	**Approx. Cable Weight (kg/mtrs)	
	AREA SQMM	Copper(Ground)		Copper(Air)		Aluminium(Ground)		Aluminium(Air)			Copper	Aluminium
		TREFOIL	FLAT	TREFOIL	FLAT	TREFOIL	FLAT	TREFOIL	FLAT			
Stranded Compacted Circular	240	412	464	604	673	321	360	470	523	72	5.40	3.99
	300	463	522	688	770	361	406	536	598	74	6.07	4.31
	400	525	594	795	895	413	464	624	699	77	7.15	4.80
	500	592	675	914	1038	470	530	724	815	80	8.24	5.30
	630	667	765	1050	1203	535	605	840	951	84	9.63	5.93
	800	740	859	1193	1387	603	685	969	1106	88	11.40	6.71
Stranded Segmental milliken overall Compacted Circular	1000	846	973	1406	1622	699	791	1157	1318	97	13.81	7.94
	1200	898	1040	1516	1762	759	860	1267	1445	101	15.79	8.68
	1600	997	1169	1740	2054	875	1001	1521	1757	109	19.85	10.46
	2000	1067	1264	1898	2265	971	1119	1721	2002	115	23.67	11.93
	2500	1131	1356	2053	2482	1046	1212	1890	2215	121	28.39	13.71

* The above data is indicative, and may vary depending on the client's specification.

** Approximate Cable weight is only for transportation guidelines.

1.8 64/110KV (E) LEAD SHEATHED

Conductor Shape	64/110KV (E) LEAD SHEATHED									Approx. Cable OD (mm)	**Approx. Cable Weight (kg/mtrs)	
	AREA SQMM	Copper(Ground)		Copper(Air)		Aluminium(Ground)		Aluminium(Air)			Copper	Aluminium
		TREFOIL	FLAT	TREFOIL	FLAT	TREFOIL	FLAT	TREFOIL	FLAT			
Stranded Compacted Circular	240	415	464	610	677	323	361	475	526	76	11.99	10.58
	300	467	523	695	774	364	406	541	602	78	12.80	11.04
	400	530	595	804	901	416	465	631	704	81	14.35	12.00
	500	599	676	925	1043	474	530	731	819	85	15.91	12.98
	630	675	766	1046	1210	540	606	850	956	89	17.86	14.16
	800	750	861	1212	1396	609	687	982	1113	93	20.28	15.59
Stranded Segmental milliken overall Compacted Circular	1000	857	974	1425	1629	706	792	1170	1323	103	23.77	17.90
	1200	910	1042	1537	1770	766	862	1284	1458	106	26.32	19.13
	1600	1009	1171	1765	2065	884	1003	1539	1766	115	31.80	22.41
	2000	1078	1266	1925	2280	979	1121	1741	2015	121	36.83	25.10
	2500	1141	1357	2081	2498	1052	1213	1911	2230	127	42.53	27.86

* The above data is indicative, and may vary depending on the client's specification.

** Approximate Cable weight is only for transportation guidelines.

1.9 64/110KV (E) CORRUGATED ALUMINIUM SHEATH

Conductor Shape	64/110KV (E) CORRUGATED ALUMINIUM SHEATH									Approx. Cable OD (mm)	**Approx. Cable Weight (kg/mtrs)	
	AREA SQMM	Copper(Ground)		Copper(Air)		Aluminium(Ground)		Aluminium(Air)			Copper	Aluminium
		TREFOIL	FLAT	TREFOIL	FLAT	TREFOIL	FLAT	TREFOIL	FLAT			
Stranded Compacted Circular	240	407	459	593	657	319	356	463	511	82	6.87	5.46
	300	455	516	673	751	358	401	527	584	84	7.56	5.80
	400	513	587	774	871	407	459	611	681	87	8.73	6.38
	500	575	666	886	1007	461	524	705	792	90	9.85	6.92
	630	642	754	1011	1165	521	597	815	922	94	11.34	7.65
	800	707	844	1140	1335	584	675	934	1068	99	13.21	8.51
Stranded Segmental milliken overall Compacted Circular	1000	791	925	1321	1554	666	777	1101	1267	108	15.79	9.92
	1200	832	1015	1413	1681	716	845	1199	1392	111	17.81	10.69
	1600	903	1132	1596	1947	808	976	1414	1675	119	22.04	12.65
	2000	954	1217	1722	2132	882	1084	1578	1896	125	25.97	14.23
	2500	997	1294	1842	2316	935	1166	1712	2082	131	30.80	16.12

* The above data is indicative, and may vary depending on the client's specification.

** Approximate Cable weight is only for transportation guidelines.

1.10 64/110KV (E) SMOOTH ALUMINIUM SHEATH

Conductor Shape	64/110KV (E) SMOOTH ALUMINIUM SHEATH									Approx. Cable OD (mm)	**Approx. Cable Weight (kg/mtrs)	
	AREA SQMM	Copper(Ground)		Copper(Air)		Aluminium(Ground)		Aluminium(Air)			Copper	Aluminium
		TREFOIL	FLAT	TREFOIL	FLAT	TREFOIL	FLAT	TREFOIL	FLAT			
Stranded Compacted Circular	240	405	461	594	664	318	358	464	516	75	6.696	5.257
	300	453	519	674	759	356	403	528	590	77	7.399	5.600
	400	510	590	775	882	405	461	613	689	80	8.542	6.144
	500	571	669	886	1021	459	526	707	802	83	9.684	6.686
	630	638	758	1011	1182	518	600	817	936	87	11.143	7.366
	800	697	849	1139	1359	579	679	936	1086	91	13.009	8.213
Stranded Segmental milliken overall Compacted Circular	1000	778	957	1321	1582	659	781	1104	1290	100	15.839	9.694
	1200	818	1020	1412	1712	707	849	1202	1417	104	17.975	10.495
	1600	887	1138	1594	1983	797	981	1416	1705	112	22.399	12.507
	2000	933	1223	1716	2196	867	1090	1580	1935	118	26.396	14.106
	2500	972	1300	1833	2364	917	1173	1713	2128	123	31.481	16.073

* The above data is indicative, and may vary depending on the client's specification.

** Approximate Cable weight is only for transportation guidelines.

1.11 64/110kV (E) CORRUGATED COPPER SHEATH

Conductor Shape	64/110kV (E) CORRUGATED COPPER SHEATH									Approx. Cable OD (mm)	**Approx. Cable Weight (Kg/mtrs)	
	AREA SQMM	Copper (Ground)		Copper (Air)		Aluminium (Ground)		Aluminium (Air)				
		TREFOIL	FLAT	TREFOIL	FLAT	TREFOIL	FLAT	TREFOIL	FLAT		Copper	Aluminium
Stranded Compacted Circular	240	406	456	588	650	318	355	459	505	84	8.388	6.949
	300	454	514	668	742	357	399	522	577	86	9.125	7.327
	400	512	586	770	860	406	458	607	677	86	10.145	7.747
	500	575	664	881	1001	460	522	702	787	89	11.339	8.341
	630	641	753	1006	1161	520	596	811	918	92	12.859	9.082
	800	706	844	1136	1331	583	675	930	1064	97	14.799	10.003
Stranded Segmental Milliken Overall Compacted Circular	1000	788	952	1317	1553	664	777	1098	1265	105	17.746	11.601
	1200	831	1015	1411	1677	716	845	1201	1394	109	19.676	12.715
	1600	903	1132	1586	1928	808	974	1403	1657	116	24.356	14.464
	2000	952	1218	1722	2130	881	1085	1578	1894	123	28.622	16.332
	2500	995	1295	1841	2314	934	1168	1714	2082	129	33.805	18.397

* The above data is indicative, and may vary depending on the client's specification.

** Approximate Cable weight is only for transportation guidelines.

1.12 64/110kV (E) CORRUGATED STAINLESS STEEL SHEATH

Conductor Shape	64/110kV (E) CORRUGATED STAINLESS STEEL SHEATH									Approx. Cable OD (mm)	**Approx. Cable Weight (Kg/mtrs)	
	AREA SQMM	Copper (Ground)		Copper (Air)		Aluminium (Ground)		Aluminium (Air)				
		TREFOIL	FLAT	TREFOIL	FLAT	TREFOIL	FLAT	TREFOIL	FLAT		Copper	Aluminium
Stranded Compacted Circular	240	414	456	594	648	322	355	461	503	85	9.490	8.052
	300	466	514	676	740	363	399	526	575	87	10.207	8.409
	400	530	585	782	859	415	457	612	671	90	11.378	8.980
	500	601	665	901	994	602	565	903	994	93	12.530	9.533
	630	680	755	1039	1154	541	596	826	911	97	14.026	10.249
	800	761	849	1186	1328	613	677	955	1059	101	15.923	11.127
Stranded Segmental Milliken Overall Compacted Circular	1000	875	964	1399	1554	714	782	1141	1261	110	18.816	12.671
	1200	935	1032	1514	1688	778	852	1253	1386	113	20.978	13.428
	1600	1050	1162	1711	1956	907	992	1503	1669	120	25.302	15.410
	2000	1138	1263	1926	2181	1020	1116	1728	1925	127	29.506	17.216
	2500	1219	1359	2099	2394	1110	1213	1911	2135	133	34.641	19.233

* The above data is indicative, and may vary depending on the client's specification.

** Approximate Cable weight is only for transportation guidelines.

1.13 76/132KV (E) POLY AL

Conductor Shape	76/132KV (E) POLY AL									Approx. Cable OD (mm)	**Approx. Cable Weight (kg/mtrs)	
	AREA SQMM	Copper(Ground)		Copper(Air)		Aluminium(Ground)		Aluminium(Air)				
		TREFOIL	FLAT	TREFOIL	FLAT	TREFOIL	FLAT	TREFOIL	FLAT		Copper	Aluminium
Stranded Compacted Circular	240	412	461	601	667	321	358	468	518	76	5.85	4.44
	300	463	520	685	763	361	404	534	593	78	6.51	4.75
	400	524	591	792	887	412	462	621	693	81	7.62	5.27
	500	591	671	910	1027	469	527	720	807	84	8.73	5.79
	630	666	761	1046	1191	534	601	836	941	88	10.14	6.44
	800	741	854	1188	1369	603	681	964	1092	93	11.97	7.27
Stranded Segmental milliken overall Compacted Circular	1000	844	967	1397	1600	697	786	1149	1300	102	14.43	8.56
	1200	897	1033	1506	1737	756	856	1259	1432	105	16.40	9.29
	1600	995	1161	1728	2023	873	994	1508	1730	114	20.52	11.13
	2000	1064	1256	1886	2236	968	1112	1708	1977	119	24.37	12.64
	2500	1127	1347	2040	2449	1041	1204	1876	2186	125	29.12	14.45

* The above data is indicative, and may vary depending on the client's specification.

** Approximate Cable weight is only for transportation guidelines.

1.14 76/132KV (E) LEAD SHEATHED*

Conductor Shape	76/132KV (E) LEAD SHEATHED									Approx. Cable OD (mm)	**Approx. Cable Weight (kg/mtrs)	
	AREA SQMM	Copper(Ground)		Copper(Air)		Aluminium(Ground)		Aluminium(Air)			Copper	Aluminium
		TREFOIL	FLAT	TREFOIL	FLAT	TREFOIL	FLAT	TREFOIL	FLAT			
Stranded Compacted Circular	240	415	462	607	670	323	359	472	521	81	13.04	11.63
	300	466	520	692	767	364	404	539	596	83	14.12	12.36
	400	529	592	800	891	415	462	627	696	86	15.47	13.12
	500	598	672	920	1031	473	528	727	809	90	17.06	14.13
	630	674	762	1059	1195	539	602	845	944	94	19.06	15.36
	800	750	855	1205	1375	609	682	974	1096	99	21.55	16.86
Stranded Segmental milliken overall Compacted Circular	1000	854	969	1414	1607	704	788	1161	1305	108	25.13	19.26
	1200	908	1035	1525	1745	763	857	1273	1438	111	27.72	20.52
	1600	1005	1163	1751	2034	880	996	1525	1740	120	33.34	23.95
	2000	1073	1257	1909	2244	974	1113	1725	1984	126	38.46	26.72
	2500	1133	1346	2062	2458	1044	1204	1891	2195	132	44.58	29.91

* The above data is indicative, and may vary depending on the client's specification.

** Approximate Cable weight is only for transportation guidelines.

1.15 76/132KV (E) CORRUGATED ALUMINIUM SHEATH

Conductor Shape	76/132KV (E) CORRUGATED ALUMINIUM SHEATH									Approx. Cable OD (mm)	**Approx. Cable Weight (kg/mtrs)	
	AREA SQMM	Copper(Ground)		Copper(Air)		Aluminium(Ground)		Aluminium(Air)			Copper	Aluminium
		TREFOIL	FLAT	TREFOIL	FLAT	TREFOIL	FLAT	TREFOIL	FLAT			
Stranded Compacted Circular	240	405	457	591	655	318	356	462	509	83	7.28	5.87
	300	453	515	670	748	357	400	525	582	85	8.01	6.25
	400	510	585	771	868	405	458	609	679	88	9.17	6.83
	500	572	663	882	1002	459	522	703	788	92	10.34	7.41
	630	636	751	1006	1161	518	595	811	919	95	11.83	8.13
	800	700	841	1134	1330	579	673	930	1055	100	13.72	9.03
Stranded Segmental milliken overall Compacted Circular	1000	782	948	1313	1547	660	774	1095	1262	109	16.39	10.52
	1200	821	1010	1404	1674	709	841	1193	1387	112	18.43	11.38
	1600	893	1125	1587	1934	801	970	1405	1664	121	22.71	13.32
	2000	939	1208	1711	2122	870	1078	1568	1888	126	26.67	14.94
	2500	981	1285	1830	2305	921	1159	1701	2073	132	31.54	16.87

* The above data is indicative, and may vary depending on the client's specification.

** Approximate Cable weight is only for transportation guidelines.

1.16 76/132kV (E) SMOOTH ALUMINIUM SHEATH

Conductor Shape	76/132kV (E) SMOOTH ALUMINIUM SHEATH									Approx. Cable OD (mm)	**Approx. Cable Weight (kg/mtrs)	
	AREA SQMM	Copper(Ground)		Copper(Air)		Aluminium(Ground)		Aluminium(Air)			Copper	Aluminium
		TREFOIL	FLAT	TREFOIL	FLAT	TREFOIL	FLAT	TREFOIL	FLAT			
Stranded Compacted Circular	240	404	459	591	659	317	357	462	512	79	7.191	5.752
	300	452	516	671	753	356	401	526	585	81	7.909	6.111
	400	509	587	772	874	404	459	610	683	84	9.069	6.671
	500	569	665	883	1011	458	523	704	795	87	10.231	7.233
	630	634	754	1007	1171	516	597	813	927	91	11.709	7.932
	800	695	844	1134	1344	577	675	932	1074	96	13.633	8.837
Stranded Segmental milliken overall Compacted Circular	1000	776	951	1314	1563	659	777	1098	1275	105	16.550	10.405
	1200	815	1013	1405	1691	705	843	1195	1399	108	18.706	11.221
	1600	884	1129	1586	1956	794	973	1408	1683	117	23.190	13.298
	2000	930	1212	1709	2145	863	1081	1570	1909	122	27.224	14.934
	2500	969	1288	1825	2329	913	1163	1703	2097	128	32.346	16.939

* The above data is indicative, and may vary depending on the client's specification.

** Approximate Cable weight is only for transportation guidelines.

1.17 76/132kV (E) CORRUGATED COPPER SHEATH

Conductor Shape	76/132kV (E) CORRUGATED COPPER SHEATH									Approx. Cable OD (mm)	**Approx. Cable Weight (Kg/mtrs)	
	AREA SQMM	Copper (Ground)		Copper (Air)		Aluminium (Ground)		Aluminium (Air)			Copper	Aluminium
		TREFOIL	FLAT	TREFOIL	FLAT	TREFOIL	FLAT	TREFOIL	FLAT			
Stranded Compacted Circular	240	405	456	587	648	318	354	459	504	85	8.778	7.340
	300	453	513	667	740	356	399	522	575	87	9.529	7.731
	400	511	583	767	859	405	456	605	671	90	10.741	8.343
	500	573	661	878	993	459	520	699	780	93	11.953	8.956
	630	639	749	1002	1150	519	593	807	910	96	13.494	9.717
	800	703	839	1131	1318	581	671	926	1054	101	15.492	10.696
Stranded Segmental Milliken Overall Compacted Circular	1000	786	946	1311	1534	662	772	1092	1250	110	18.528	12.383
	1200	827	1008	1403	1660	712	840	1194	1380	113	20.445	13.585
	1600	899	1124	1578	1906	804	968	1394	1638	120	25.170	15.278
	2000	947	1208	1713	2105	876	1077	1569	1872	127	29.483	17.193
	2500	990	1283	1833	2285	929	1158	1703	2059	133	34.701	19.294

* The above data is indicative, and may vary depending on the client's specification.

** Approximate Cable weight is only for transportation guidelines.

1.18 76/132kV (E) CORRUGATED STAINLESS STEEL SHEATH

Conductor Shape	76/132kV (E) CORRUGATED STAINLESS STEEL SHEATH									Approx. Cable OD (mm)	**Approx. Cable Weight (Kg/mtrs)	
	AREA SQMM	Copper (Ground)		Copper (Air)		Aluminium (Ground)		Aluminium (Air)			Copper	Aluminium
		TREFOIL	FLAT	TREFOIL	FLAT	TREFOIL	FLAT	TREFOIL	FLAT			
Stranded Compacted Circular	240	414	455	592	644	322	535	460	500	90	10.023	8.585
	300	466	512	674	735	362	398	524	571	92	10.771	8.972
	400	530	583	780	853	415	455	610	660	95	11.936	9.538
	500	601	662	898	987	473	520	707	774	98	13.122	10.125
	630	680	752	1035	1145	540	594	822	904	101	14.636	10.859
	800	761	845	1181	1315	612	673	950	1048	106	16.619	11.823
Stranded Segmental Milliken Overall Compacted Circular	1000	874	959	1391	1538	713	779	1134	1248	115	19.581	13.436
	1200	934	1026	1505	1670	778	849	1252	1380	118	21.748	14.206
	1600	1049	1156	1930	1934	905	987	1492	1650	125	26.098	16.206
	2000	1137	1256	1915	2155	1018	1110	1715	1902	132	30.347	18.057
	2500	1218	1352	2089	2376	1108	1207	1899	2113	137	35.519	20.111

* The above data is indicative, and may vary depending on the client's specification.

** Approximate Cable weight is only for transportation guidelines.

1.19 127/220KV (E) POLY AL

Conductor Shape	127/220KV (E) POLY AL									Approx. Cable OD (mm)	**Approx. Cable Weight (kg/mtrs)	
	AREA SQMM	Copper(Ground)		Copper(Air)		Aluminium(Ground)		Aluminium(Air)			Copper	Aluminium
		TREFOIL	FLAT	TREFOIL	FLAT	TREFOIL	FLAT	TREFOIL	FLAT			
Stranded Compacted Circular	400	520	578	777	854	-		-		99	9.92	-
	500	586	657	894	991	465	516	707	778	100	10.80	7.86
	630	659	745	1029	1153	528	589	821	911	101	11.97	8.28
	800	732	836	1169	1323	595	667	946	1056	106	13.87	9.18
Stranded Segmental milliken overall Compacted Circular	1000	829	947	1373	1558	685	770	1128	1266	111	15.92	10.05
	1200	880	1011	1480	1690	742	838	1237	1394	114	17.87	10.75
	1600	974	1135	1699	1970	854	972	1481	1686	122	22.11	12.72
	2000	1041	1225	1852	2168	946	1086	1674	1919	128	26.04	14.30
	2500	1097	1311	2007	2389	1014	1176	1844	2137	132	30.52	15.84

* The above data is indicative, and may vary depending on the client's specification.

** Approximate Cable weight is only for transportation guidelines.

KEI
Wires and Cables
The power behind the power

1.20 127/220KV (E) LEAD SHEATHED

Conductor Shape	127/220KV (E) LEAD SHEATHED									Approx. Cable OD (mm)	**Approx. Cable Weight (kg/mtrs)	
	AREA SQMM	Copper(Ground)		Copper(Air)		Aluminium(Ground)		Aluminium(Air)			Copper	Aluminium
		TREFOIL	FLAT	TREFOIL	FLAT	TREFOIL	FLAT	TREFOIL	FLAT			
Stranded Compacted Circular	400	523	579	784	859	-		-		104	20.70	-
	500	591	658	903	997	468	517	713	783	105	21.68	18.75
	630	665	746	1039	1158	532	590	828	915	107	23.06	19.36
	800	740	837	1182	1330	600	668	955	1061	112	25.67	20.97
Stranded Segmental milliken overall Compacted Circular	1000	836	948	1388	1566	690	772	1139	1273	117	28.53	22.66
	1200	888	1013	1496	1698	748	839	1249	1401	120	30.74	23.53
	1600	981	1135	1715	1975	859	973	1493	1691	129	36.54	27.15
	2000	1045	1223	1868	2175	949	1085	1686	1926	135	41.78	30.05
	2500	1104	1307	2020	2382	1017	1173	1852	2133	140	47.23	32.55

* The above data is indicative, and may vary depending on the client's specification.

** Approximate Cable weight is only for transportation guidelines.

1.21 127/220KV (E) CORRUGATED ALUMINIUM SHEATH

Conductor Shape	127/220KV (E) CORRUGATED ALUMINIUM SHEATH									Approx. Cable OD (mm)	**Approx. Cable Weight (kg/mtrs)	
	AREA SQMM	Copper(Ground)		Copper(Air)		Aluminium(Ground)		Aluminium(Air)			Copper	Aluminium
		TREFOIL	FLAT	TREFOIL	FLAT	TREFOIL	FLAT	TREFOIL	FLAT			
Stranded Compacted Circular	400	503	570	754	832	-		-		111	11.94	-
	500	562	646	862	962	453	509	687	757	112	12.84	9.90
	630	626	731	985	1114	510	580	793	882	114	14.05	10.35
	800	688	817	1111	1273	570	655	908	1020	119	16.07	11.37
Stranded Segmental milliken overall Compacted Circular	1000	763	920	1285	1489	646	753	1071	1216	124	18.19	12.32
	1200	799	979	1375	1612	693	817	1166	1334	126	20.20	13.06
	1600	856	1083	1544	1854	771	938	1367	1598	136	25.20	15.81
	2000	899	1159	1655	2029	835	1038	1527	1809	141	29.26	17.52
	2500	934	1227	1780	2207	879	1112	1654	1991	147	34.27	19.60

* The above data is indicative, and may vary depending on the client's specification.

** Approximate Cable weight is only for transportation guidelines.

1.22 127/220kV (E) SMOOTH ALUMINIUM SHEATH

Conductor Shape	127/220kV (E) SMOOTH ALUMINIUM SHEATH									Approx. Cable OD (mm)	**Approx. Cable Weight (kg/mtrs)	
	AREA SQMM	Copper(Ground)		Copper(Air)		Aluminium(Ground)		Aluminium(Air)			Copper	Aluminium
		TREFOIL	FLAT	TREFOIL	FLAT	TREFOIL	FLAT	TREFOIL	FLAT			
Stranded Compacted Circular	400	502	574	759	844	-	-	-	-	102	11.650	9.252
	500	562	651	868	978	452	512	692	769	103	12.564	9.566
	630	625	737	992	1134	510	584	800	898	104	13.826	10.049
	800	685	825	1120	1306	568	661	918	1045	106	15.405	10.609
Stranded Segmental milliken overall Compacted Circular	1000	761	930	1296	1527	645	760	1083	1246	112	17.895	11.750
	1200	799	991	1387	1655	691	825	1179	1370	115	19.948	12.452
	1600	865	1101	1567	1911	777	951	1388	1644	123	24.525	14.633
	2000	910	1180	1689	2093	844	1054	1549	1863	129	28.618	16.328
	2500	948	1251	1805	2270	892	1131	1680	2046	135	33.808	18.401

* The above data is indicative, and may vary depending on the client's specification.

** Approximate Cable weight is only for transportation guidelines.

1.23 127/220kV (E) CORRUGATED COPPER SHEATH

Conductor Shape	127/220kV (E) CORRUGATED COPPER SHEATH									Approx. Cable OD (mm)	**Approx. Cable Weight (Kg/mtrs)	
	AREA SQMM	Copper (Ground)		Copper (Air)		Aluminium (Ground)		Aluminium (Air)			Copper	Aluminium
		TREFOIL	FLAT	TREFOIL	FLAT	TREFOIL	FLAT	TREFOIL	FLAT			
Stranded Compacted Circular	400	505	571	754	832	-	-	-	-	107	13.609	11.211
	500	565	647	864	964	454	510	687	758	108	14.419	11.422
	630	630	733	987	1116	512	581	794	884	110	15.718	11.941
	800	692	821	1116	1284	572	658	912	1027	112	17.336	12.539
Stranded Segmental Milliken Overall Compacted Circular	1000	770	925	1293	1500	650	756	1076	1224	118	19.947	13.802
	1200	811	985	1385	1622	699	822	1178	1350	121	21.760	14.946
	1600	880	1095	1558	1860	787	945	1374	1600	128	26.593	16.701
	2000	927	1175	1692	2051	857	1049	1546	1825	135	30.944	18.654
	2500	968	1246	1811	2224	907	1126	1679	2003	141	36.241	20.834

* The above data is indicative, and may vary depending on the client's specification.

** Approximate Cable weight is only for transportation guidelines.

1.24 127/220kV (E) CORRUGATED STAINLESS STEEL SHEATH

Conductor Shape	127/220kV (E) CORRUGATED STAINLESS STEEL SHEATH									Approx. Cable OD (mm)	**Approx. Cable Weight (Kg/mtrs)	
	AREA SQMM	Copper (Ground)		Copper (Air)		Aluminium (Ground)		Aluminium (Air)			Copper	Aluminium
		TREFOIL	FLAT	TREFOIL	FLAT	TREFOIL	FLAT	TREFOIL	FLAT			
Stranded Compacted Circular	400	527	572	768	829	-	-	-	-	112	15.188	12.790
	500	596	650	885	961	469	511	696	754	113	16.119	13.121
	630	675	738	1020	1115	535	583	809	880	115	17.410	13.633
	800	754	830	1166	1285	605	661	936	1024	117	18.976	14.180
Stranded Segmental Milliken Overall Compacted Circular	1000	861	942	1373	1509	702	764	1118	1224	123	21.517	15.372
	1200	920	1007	1486	1638	764	833	1230	1350	125	23.610	16.019
	1600	1032	1133	1708	1898	889	968	1471	1620	132	28.032	18.140
	2000	1117	1230	1890	2113	999	1089	1690	1865	139	32.355	20.064
	2500	1197	1322	2060	2317	1086	1180	1868	2067	145	37.615	22.208

* The above data is indicative, and may vary depending on the client's specification.

** Approximate Cable weight is only for transportation guidelines.

1.25 190/330kV (E) POLY AL

Conductor Shape	190/330kV (E) POLY AL									Approx. Cable OD (mm)	**Approx. Cable Weight (kg/mtrs)	
	AREA SQMM	Copper(Ground)		Copper(air)		Aluminium(Ground)		Aluminium(Air)			Copper	Aluminium
		TREFOIL	FLAT	TREFOIL	FLAT	TREFOIL	FLAT	TREFOIL	FLAT			
Stranded Compacted Circular	630	632	725	1004	1127	510	574	804	892	110	16.209	11.621
	800	680	808	1125	1296	561	648	918	1037	113	18.092	12.392
Stranded Segmental milliken overall Compacted Circular	1000	752	909	1303	1518	634	743	1084	1238	118	20.570	13.396
	1200	787	968	1401	1657	680	806	1186	1369	117	22.099	13.510
	1600	852	1074	1587	1919	763	926	1401	1650	125	26.662	15.437
	2000	897	1149	1713	2100	829	1025	1566	1868	131	30.900	17.065
	2500	932	1218	1833	2286	874	1100	1701	2058	136	36.288	19.066

* The above data is indicative, and may vary depending on the client's specification.

** Approximate Cable weight is only for transportation guidelines.

1.26 190/330kV (E) LEAD SHEATHED

Conductor Shape	190/330kV (E) LEAD SHEATHED									Approx. Cable OD (mm)	**Approx. Cable Weight (kg/mtrs)	
	AREA SQMM	Copper(Ground)		Copper(air)		Aluminium(Ground)		Aluminium(Air)			Copper	Aluminium
		TREFOIL	FLAT	TREFOIL	FLAT	TREFOIL	FLAT	TREFOIL	FLAT			
Stranded Compacted Circular	630	648	729	1026	1140	519	577	818	901	114	27.140	21.973
	800	718	816	1167	1311	583	652	943	1046	118	29.617	23.298
Stranded Segmental milliken overall Compacted Circular	1000	806	921	1364	1539	667	750	1121	1252	123	32.803	25.018
	1200	852	985	1475	1680	720	814	1232	1384	123	34.468	25.163
	1600	935	1097	1690	1961	820	941	1473	1679	129	39.891	28.004
	2000	992	1179	1837	2157	902	1047	1661	1911	135	45.823	31.122
	2500	1042	1254	1978	2347	962	1127	1815	2104	142	52.777	34.730

* The above data is indicative, and may vary depending on the client's specification.

** Approximate Cable weight is only for transportation guidelines.

1.27 190/330kV (E) CORRUGATED ALUMINIUM SHEATH

Conductor Shape	190/330kV (E) CORRUGATED ALUMINIUM SHEATH									Approx. Cable OD (mm)	**Approx. Cable Weight (kg/mtrs)	
	AREA SQMM	Copper(Ground)		Copper(air)		Aluminium(Ground)		Aluminium(Air)			Copper	Aluminium
		TREFOIL	FLAT	TREFOIL	FLAT	TREFOIL	FLAT	TREFOIL	FLAT			
Stranded Compacted Circular	630	608	711	969	1090	497	565	781	864	124	17.038	12.409
	800	664	793	1093	1248	553	638	894	1001	127	19.007	13.260
Stranded Segmental milliken overall Compacted Circular	1000	731	889	1260	1456	622	730	1051	1190	132	21.624	14.397
	1200	763	944	1349	1582	663	789	1145	1311	132	23.380	14.744
	1600	823	1043	1542	1823	741	904	1348	1572	140	28.162	16.862
	2000	863	1114	1643	1987	801	998	1503	1779	145	32.733	18.686
	2500	896	1176	1757	2165	843	1067	1630	1954	151	38.104	20.791

* The above data is indicative, and may vary depending on the client's specification.

** Approximate Cable weight is only for transportation guidelines.

1.28 190/330kV (E) SMOOTH ALUMINIUM SHEATH

Conductor Shape	190/330kV (E) SMOOTH ALUMINIUM SHEATH									Approx. Cable OD (mm)	**Approx. Cable Weight (kg/mtrs)	
	AREA SQMM	Copper(Ground)		Copper(air)		Aluminium(Ground)		Aluminium(Air)			Copper	Aluminium
		TREFOIL	FLAT	TREFOIL	FLAT	TREFOIL	FLAT	TREFOIL	FLAT			
Stranded Compacted Circular	630	610	716	975	1104	498	568	786	874	116	15.085	11.308
	800	668	799	1101	1265	554	641	900	1007	119	16.897	12.101
Stranded Segmental milliken overall Compacted Circular	1000	737	897	1271	1477	625	735	1060	1206	124	19.381	13.236
	1200	770	954	1363	1609	667	796	1157	1333	123	20.817	13.318
	1600	831	1056	1540	1858	747	913	1362	1601	131	25.249	15.357
	2000	872	1129	1661	2033	809	1009	1520	1811	136	29.368	17.078
	2500	908	1193	1776	2204	853	1080	1649	1987	142	34.586	19.179

* The above data is indicative, and may vary depending on the client's specification.

** Approximate Cable weight is only for transportation guidelines.

1.29 190/330kV (E) CORRUGATED COPPER SHEATH

Conductor Shape	190/330kV (E) CORRUGATED COPPER SHEATH									Approx. Cable OD (mm)	**Approx. Cable Weight (Kg/mtrs)	
	AREA SQMM	Copper (Ground)		Copper (Air)		Aluminium (Ground)		Aluminium (Air)			Copper	Aluminium
		TREFOIL	FLAT	TREFOIL	FLAT	TREFOIL	FLAT	TREFOIL	FLAT			
Stranded Compacted Circular	630	615	713	973	1092	500	566	782	865	119	17.169	13.392
	800	675	796	1099	1250	558	639	896	1000	123	19.069	14.273
Stranded Segmental Milliken Overall	1000	746	894	1270	1459	630	732	1056	1191	128	21.607	15.462
	1200	781	951	1363	1588	674	794	1158	1322	127	22.735	15.730
	1600	845	1054	1534	1823	756	910	1352	1569	133	27.409	17.517
Compacted Circular	2000	888	1127	1666	2008	820	1788	1520	1007	140	31.790	19.499
	2500	925	1192	1783	2176	867	1078	1651	1961	146	36.966	21.559

* The above data is indicative, and may vary depending on the client's specification.

** Approximate Cable weight is only for transportation guidelines.

1.30 190/330kV (E) CORRUGATED STAINLESS STEEL SHEATH

Conductor Shape	190/330kV (E) CORRUGATED STAINLESS STEEL SHEATH									Approx. Cable OD (mm)	**Approx. Cable Weight (Kg/mtrs)	
	AREA SQMM	Copper (Ground)		Copper (Air)		Aluminium (Ground)		Aluminium (Air)			Copper	Aluminium
		TREFOIL	FLAT	TREFOIL	FLAT	TREFOIL	FLAT	TREFOIL	FLAT			
Stranded Compacted Circular	630	661	721	1006	1093	524	569	797	863	124	18.593	14.816
	800	738	809	1148	1256	592	645	921	1001	127	20.453	15.657
Stranded Segmental Milliken Overall	1000	839	915	1349	1475	683	743	1098	1196	132	22.960	16.815
	1200	891	976	1463	1609	741	808	1215	1330	131	24.404	16.831
	1600	996	1095	1682	1864	857	936	1447	1591	137	28.677	18.785
Compacted Circular	2000	1076	1186	1860	2074	961	1048	1661	1831	144	33.073	20.783
	2500	1150	1272	2027	2274	1043	1136	1835	2028	150	38.341	22.933

* The above data is indicative, and may vary depending on the client's specification.

** Approximate Cable weight is only for transportation guidelines.

1.31 220/400KV (E) POLY AL

Conductor Shape	220/400KV (E) POLY AL					Approx. Cable OD (mm)	**Approx. Cable Weight (kg/mtrs)	
	AREA SQMM	Copper(Ground)	Copper(Air)	Aluminium (Ground)	Aluminium(Air)		Copper	Aluminium
		FLAT	FLAT	FLAT	FLAT			
Stranded Compacted	630	741	1111	564	878	116	14.12	10.43
	800	798	1278	638	1020	119	15.74	11.04
Stranded Segmental milliken overall	1000	898	1502	731	1221	123	17.69	11.82
	1200	957	1634	794	1354	124	19.30	12.26
	1600	1067	1900	916	1627	132	23.63	14.24
Compacted Circular	2000	1148	2099	1018	1859	136	27.39	15.66
	2500	1222	2292	1097	2052	142	32.28	17.61

* The above data is indicative, and may vary depending on the client's specification.

** Approximate Cable weight is only for transportation guidelines.

1.32 220/400KV (E) LEAD SHEATHED

Conductor Shape	220/400KV (E) LEAD SHEATHED					Approx. Cable OD (mm)	**Approx. Cable Weight (kg/mtrs)	
	AREA SQMM	Copper(Ground)	Copper(Air)	Aluminium(Ground)	Aluminium(Air)		Copper	Aluminium
		FLAT	FLAT	FLAT	FLAT			
Stranded Compacted	630	714	1114	565	880	124	29.5	25.71
	800	799	1282	639	1023	126	31.4	26.57
Stranded Segmental milliken overall	1000	899	1507	732	1225	130	33.8	27.77
	1200	958	1640	795	1359	131	35.9	28.69
	1600	1067	1902	916	1630	140	41.6	32.06
Compacted Circular	2000	1145	2096	1016	1857	145	46.7	34.72
	2500	1217	2286	1093	2048	151	53.0	38.00

* The above data is indicative, and may vary depending on the client's specification.

** Approximate Cable weight is only for transportation guidelines.

1.33 220/400 KV (E) CORRUGATED ALUMINIUM SHEATH

Conductor Shape	220/400 KV (E) CORRUGATED ALUMINIUM SHEATH					Approx. Cable OD (mm)	**Approx. Cable Weight (kg/mtrs)	
	AREA SQMM	Copper(Ground)	Copper(Air)	Aluminium(Ground)	Aluminium(Air)		Copper	Aluminium
		FLAT	FLAT	FLAT	FLAT			
Stranded Compacted	630	697	1076	555	853	130	17.26	13.57
	800	777	1233	625	989	132	18.98	14.28
Stranded Segmental milliken overall	1000	868	1439	713	1177	136	21.01	15.14
	1200	921	1558	771	1300	137	22.64	15.59
	1600	1014	1791	880	1545	146	27.20	17.81
Compacted Circular	2000	1081	1962	969	1750	150	31.07	19.33
	2500	1138	2132	1034	1916	156	36.12	21.45

* The above data is indicative, and may vary depending on the client's specification.

** Approximate Cable weight is only for transportation guidelines.

1.34 220/400kV (E) SMOOTH ALUMINIUM SHEATH

Conductor Shape	220/400kV (E) SMOOTH ALUMINIUM SHEATH					Approx. Cable OD (mm)	**Approx. Cable Weight (kg/mtrs)	
	AREA SQMM	Copper(Ground)	Copper(Air)	Aluminium(Ground)	Aluminium(Air)		Copper	Aluminium
		FLAT	FLAT	FLAT	FLAT			
Stranded Compacted	630	704	1092	559	866	119	16.129	12.352
	800	785	1253	630	1003	121	17.818	13.021
Stranded Segmental milliken overall	1000	877	1459	719	1192	125	20.075	13.930
	1200	933	1590	779	1318	126	21.816	14.310
	1600	1030	1832	891	1578	135	26.561	16.669
Compacted Circular	2000	1099	2009	983	1790	139	30.435	18.145
	2500	1160	2176	1051	1963	145	35.700	20.292

* The above data is indicative, and may vary depending on the client's specification.

** Approximate Cable weight is only for transportation guidelines.

1.35 220/400kV (E) CORRUGATED COPPER SHEATH

Conductor Shape	220/400kV (E) CORRUGATED COPPER SHEATH					Approx. Cable OD (mm)	**Approx. Cable Weight (Kg/mtrs)	
	AREA SQMM	Copper (Ground)	Copper (Air)	Aluminium (Ground)	Aluminium (Air)		Copper	Aluminium
		FLAT	FLAT	FLAT	FLAT			
Stranded Compacted Circular	630	697	1068	554	847	130	19.402	15.625
	800	777	1239	624	987	133	21.132	16.336
Stranded Segmental Milliken Overall Compacted Circular	1000	869	1426	713	1165	137	23.346	17.201
	1200	922	1545	771	1287	138	24.811	17.829
	1600	1020	1769	882	1524	144	29.546	19.654
	2000	1087	1954	973	1741	149	33.582	21.292
	2500	1146	2115	1039	1907	155	38.955	23.547

* The above data is indicative, and may vary depending on the client's specification.

** Approximate Cable weight is only for transportation guidelines.

1.36 220/400kV (E) CORRUGATED STAINLESS STEEL SHEATH

Conductor Shape	220/400kV (E) CORRUGATED STAINLESS STEEL SHEATH					Approx. Cable OD (mm)	**Approx. Cable Weight (Kg/mtrs)	
	AREA SQMM	Copper (Ground)	Copper (Air)	Aluminium (Ground)	Aluminium (Air)		Copper	Aluminium
		FLAT	FLAT	FLAT	FLAT			
Stranded Compacted Circular	630	708	1077	559	850	131	21.136	17.359
	800	793	1239	633	987	133	22.826	18.030
Stranded Segmental Milliken Overall Compacted Circular	1000	895	1454	727	1180	137	25.154	19.009
	1200	954	1581	790	1307	137	26.906	19.321
	1600	1069	1827	913	1559	145	31.404	21.512
	2000	1155	2039	1021	1799	150	35.579	23.289
	2500	1237	2234	1105	1992	156	40.869	25.461

* The above data is indicative, and may vary depending on the client's specification.

** Approximate Cable weight is only for transportation guidelines.

RATING FACTORS

A. Rating factors for variation in ambient air temperature

Air Temperature (Deg C)	30	35	40	45	50	55
	1.11	1.05	1.00	0.94	0.88	0.81

B. Rating factors for variation in ground temperature

Ground Temperature (Deg C) Rating Factor	25	30	35	40	45	50
	1.04	1.00	0.96	0.91	0.86	0.81

C. Rating factors for variation in Thermal Resistivity of soil

Thermal Resistivity (OC cm/w) Rating Factor	100	120	150	200	250	300
	1.19	1.10	1.00	0.88	0.80	0.72

D. Rating factors for variation in Depth of laying

Depth of laying (m) Rating Factor	0.5	0.7	0.9	1.0	1.2	1.5
	1.13	1.09	1.06	1.04	1.02	1.00

E. Group Rating factors : Group rating factors for cables laid in formed concrete trenches with removable covers on cable troughs where air circulation is restricted. The cables spaced by one cable diameter and trays in tiers by 300 mm. The clearance of the cable from the wall is 20mm.

No. of troughs	No. of groups (Circuits)		
	1	2	3
1	0.92	0.89	0.88
2	0.87	0.84	0.83
3	0.84	0.82	0.81
6	0.82	0.80	0.79

F. Group Rating factors : Group rating factors for cables laid on racks. The cables spaced by one cable diameter and racks in tiers by 300mm. The clearance between the wall and the cable is 20mm.

No. of troughs	No. of groups (Circuits)		
	1	2	3
1	1.00	0.97	0.96
2	0.97	0.94	0.93
3	0.96	0.93	0.92
6	0.94	0.91	0.90

G. Group rating factors for cables laid in ground in horizontal formation

Axis distance between groups	No. of groups (Circuits)	
	2	3
200 mm	0.81	0.71
400 mm	0.85	0.77
600 mm	0.88	0.81
800 mm	0.90	0.84
1000 mm	0.96	0.93

REFERENCE TEST VOLTAGES (Table 1)

Rated Voltages of cables	Highest voltage for equipment between conductors	30 min voltage test	Partial discharge test	Tan delta measurement	Heating cycle test	Impulse withstand test	15 min power frequency voltage test after Impulse test
U ₀ /U kV	U _m kV	2.5 U ₀ kV	1.5 U ₀ kV	U ₀ kV	2 U ₀ kV	kV	2.5 U ₀ kV
38/66	72.5	90	57	38	76	325	90
64/110	123	160	96	64	128	550	160
76/132	145	190	114	76	152	650	190
127/220	245	318	190	127	254	1050	315
220/400	420	440	330	220	440	1425	440

* Test voltages are generally in line with IEC 60840/ IS :7098 Part 3/IEC:62067

CONDUCTOR RESISTANCE (Table 2)

Cross-sectional area of conductor	Max D.C. Resistance of conductor at 20°C		App. A. C. resistance of conductor at 90°C	
	Aluminium conductor	Copper conductor	Aluminium conductor	Copper conductor
sq.mm.	ohm/ km	ohm/ km	ohm/ km	ohm/ km
240	0.1250	0.0754	0.1610	0.0972
300	0.1000	0.0601	0.1290	0.0780
400	0.0778	0.0470	0.1010	0.0618
500	0.0605	0.0366	0.0791	0.0491
630	0.0469	0.0283	0.0622	0.0393
800	0.0367	0.0221	0.0497	0.0322
1000	0.0291	0.0176	0.0380	0.0236
1200	0.0247	0.0151	0.0326	0.0207
1600	0.0186	0.0113	0.0251	0.0163
2400	0.0149	0.0090	0.273	0.019
2500	0.0127	0.0072	0.305	0.016

MAX. PERMISSIBLE SHORT-CIRCUIT CURRENTS FOR CONDUCTOR

MAX. PERMISSIBLE SHORT-CIRCUIT CURRENTS FOR ONE SECOND.			
Conductor Shape	Cross-Sectional Area of conductor. Sq.mm	Short Circuit rating for 1 Sec.	
		Aluminium K.Amps (rms)	Copper K.Amps (rms)
Stranded Compacted Circular	240	22.6	34.3
	300	28.2	42.9
	400	37.6	57.2
	500	47.0	71.5
	630	59.2	90.1
	800	75.2	114.4
Stranded Segmental milliken overall Compacted Circular	1000	94.5	143.0
	1200	113.4	171.6
	1600	152.4	228.8
	2000	189.0	286.0
	2500	236.2	357.5

PERMISSIBLE SHORT CIRCUIT CURRENTS.

The permissible short circuit current of a cable is determined by the maximum permissible conductor temperature and by the duration of the short circuit current. At high peak currents, the dynamic forces between the conductors must be taken into account.

The short circuit capacity of the conductor and metallic screen of cable are related principally to their heat capacities and are limited by the maximum temperature permitted under short circuit XLPE power are 90 deg.C at normal operation and 250 deg.C at short circuit operation.

According to IEC 60949 based formula:-

$$I = \epsilon \times I_{AD}$$

- I Permissible Short Circuit Current
- ϵ Factor to allow for heat loss into adjacent components
- I_{AD} Short circuit current calculated on adiabatic basis

$$I_{AD}^2 t = K^2 S^2 \ln \left(\frac{\theta_f + \beta}{\theta_i + \beta} \right)$$

Where;

- t Duration of short circuit (Sec.)
- s Geometrical Cross sectional area of current carrying component (sq.mm)
- θ_i Initial Temperature (90 deg.C)
- θ_f Final Temperature (250 deg.C)
- β Reciprocal of temperature coefficient of resistance of current carrying conductor at 0 deg.C
- k Constant depending upon the material of current carrying component.

Values for constant are as below:-

- k Aluminium: 148
Copper: 226
- β Aluminium: 228
Copper: 234.5

CABLE HANDLING AND STORAGE

1. Introduction

This directive describes the mandatory transportation handling and storage conditions for high voltage cables by KEI Cables. Failure to observe those instructions may cause a loss of warranty.

2. Transportation handling instructions

During transportation the following basic rules must be observed under all circumstances to avoid any damages to the drum and the cable. The pictogram shown below, which is also to be found at the cable drum, indicates the main rules accordingly.

- Don't drop the drum, not even from small heights.
- Securely protect the drum against moving.
- Always use axle spreader when lifting the drum with a crane.
- Use lifting equipment with appropriate lifting capacity.
- Avoid mechanical stress of the wooden protection.
- Place rubber mats underneath the drum when loaded onto a trailer.
- Observe high centre of gravity when loaded on a trailer.
- Do not remove the fastening support of the drum until cable pulling begins.

It's the duty of the freight forwarder to ensure a safe transport and to use intact equipment only.

Especially the following issues need to be carefully taken into account:

- Height and width clearance of all roads, tunnels and bridges to be passed.
- Width of the roads and sufficient load capacity.
- Curve radii, inclinations, bumps, holes, tilt angles of the roads.
- Sufficient loading capacity and braking force of the trailer and towing vehicle.
- For ship transport: proper fixing of the drums to avoid falling from deck or being harmed by a storm.

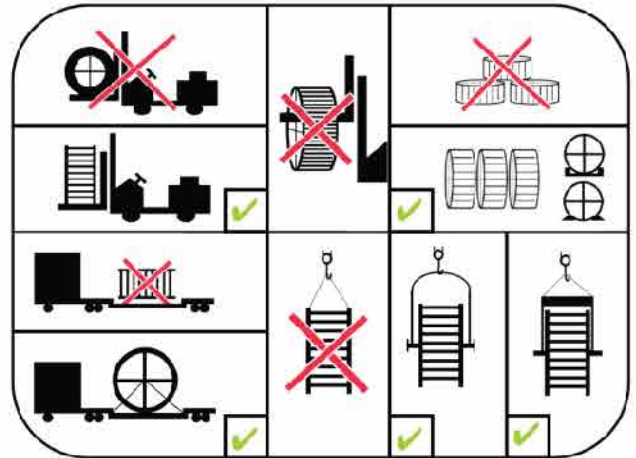

3. Transportation and Storage conditions

It is important throughout the entire transportation and storage duration that the permissible ambient temperature of the cables on their drums is respected. The following table lists the permissible ambient temperatures for different cable types on their drums.

Cable Type	Ambient Temperature Range	Relative Humidity
XLPE insulated cables with HDPE or PVC outer sheath	-20°C .. +50°C	Up to 100%, condensing
XLPE insulated cables with FRNC outer sheath	-5°C .. +35°C (*)	Up to 100%, condensing
Oil filled cables with HDPE or PVC outer sheath	-20°C .. +50°C	Up to 100%, condensing

(*): Under Consideration

In addition the following conditions must be ensured throughout the entire transportation and storage duration:

- The cables must be protected against mechanical damage, e.g. by wood lagging or Steel sheet Packing of the drums.
- The cables must be protected against direct sun radiation, e.g. by wood lagging or Steel sheet packing of the Drums or kept under a suitable roof.
- The drums must always be standing upright; do not tilt the drums or lay them on their side.
- Store the heavy drums (↑5MT) only on firm ground such as concrete or asphalt.

Note:

4. Cable laying conditions

During the cable laying process the cable temperature has to be within the permissible range to avoid any damages of the cable's outer sheath. In case the ambient temperature was not continuously maintained within this temperature range during 48 hours prior to the cable laying process, appropriate counter measures have to be taken to ensure the correct cable temperature.

In case of project-related questions regarding above instructions please contact the responsible project engineer for help.

Further and more detailed information may be provided along with the project-specific documentation.



THE SPECS

MANUFACTURING UNITS

A large infrastructure, spread over an area of 2,49,576 sq. metres across three strategically located units, supported by state-of-the-art production units, gives KEI the strength to meet the varied needs of its wide client base.



CABLE LAYOUT AND SYSTEM DESIGN

The dimensioning of a high voltage cable system is always based on the specifications and demands of the project at hand. The following details are required for calculation:

- The type of cable insulation
- Nominal and maximum operating voltage
- Short-circuit capacity or short-circuit current with statement of the effect time
- Transmission capacity or nominal current
- Operating mode: permanent operation or partial load operation (load factors)
- Ambient conditions:
 - Type of installation
 - Ambient temperature
 - Special thermal resistance of the ground

The calculation of the admissible load currents (ampacity) and the cable temperature is performed in accordance with the IEC publication 60287. At KEI, professional computer programs are in use for the calculation of the various cable data.

1.1 ELECTRICAL FIELD

In initial approximation, the main insulation of a high voltage XLPE cable can be regarded as a homogeneous cylinder. Its field distribution or voltage gradient is therefore represented by a homogeneous radial field. The value of the voltage gradient at a point x within the insulation can be calculated as:

$$E_x = U_o / r_x \cdot \ln (r_a / r_i) \text{ (kV/mm)}$$

U_o = Operating voltage (kV)

r_x = Radius at position x (mm)

r_a = External radius above the insulation (mm)

r_i = Radius of the internal field diameter (mm)

The electrical field strength is highest at the inner semiconductor and lowest above the insulation. (below the external semiconductor, $r_x = r_a$)

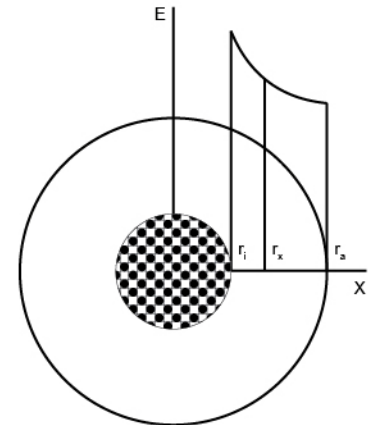

1.2 CAPACITY, CHARGING CURRENT

The operating capacity depends on the type of insulation and its geometry. The following formula applies for all radial field cables :

$$C = E_r / 18 \cdot \ln (D/d) \text{ (}\mu\text{F/km)}$$

With E_r = Relative permittivity (XLPE: 2.5)

D = Diameter over main insulation excluding screen (mm)

d = Diameter over conductor including screen (mm)

Single-core high voltage XLPE cables represent an extended capacitance with a homogeneous radial field distribution.

Thus a capacitive charging current to earth results in the following formula:

$$I_c = U_o \cdot \omega \cdot C \text{ (A/km)}$$

With U_o = Operating voltage (kV)

ω = Angular frequency (1/s) C = Operating capacity ($\mu\text{F/km}$)

1.3 INDUCTANCE, INDUCTIVE REACTANCE

The operating inductance in general depends on the relation between the conductor axis spacing and the external conductor diameter. Practically, two cases have to be considered:

LAYING FORMATION: TREFOIL

The operating inductance for all three phases calculated as:

$$L = 2 \cdot 10^{-4} \cdot \ln [a / 0.779 \cdot r_L] \text{ (H/Km)}$$

with

a = Phase Axis distance (mm)

r_L = Diameter of conductor over inner semiconducting layer (mm)

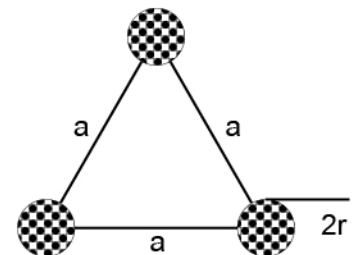

LAYING FORMATION: FLAT

The mean operating inductance for the three phases calculates for both cases as:

$$L_m = 2 \cdot 10^{-4} \cdot \ln [a' / 0.779 \cdot r_L] \text{ (H/km)}$$

With

$a' = \sqrt[3]{2 \cdot a}$ Mean geometric distance (mm)

a = Phase axis distance (mm)

r_L = Diameter of conductor over inner semiconducting layer (mm)

The inductive reactance of the cable system calculates for both cases as:

$$X = \omega \cdot L \text{ (}\Omega/\text{km)}$$

With ω = Angular frequency (1/s)





1.4 DIRECT CURRENT RESISTANCE

The maximum DC resistance values of conductors at 20°C are shown in cable standards. The DC resistance at other conductor temperatures may be calculated using the equation given below:

$$R_t = R_{20} [1 + \alpha_{20} (t - 20^\circ\text{C})]$$

R_t = DC resistance at temperature t , Ω/km

R_{20} = DC resistance of conductor at 20°C, Ω/km

T = temperature of conductor, °C

α_{20} = temperature coefficient of resistance at 20°C, 1/°C

For Copper conductors $\alpha_{20}=0.0393$

For Aluminium conductor and sheath $\alpha_{20}=0.0403$

For Lead alloy sheath $\alpha_{20}=0.0400$

Maximum DC resistance of conductors at 20°C (in accordance with IEC 60228/IS: 8130). Calculated DC resistance of metallic sheaths and metallic screens at 20°C

1.5 LOSSES IN CABLES

Voltage- dependent and current- dependent power losses occur in cables.

I) Voltage – dependent losses.

Voltage- dependent power losses are caused by polarization effects within the main insulation.

They calculate to:

$$P_d = U_o^2 \omega C \tan \delta \quad (\omega/\text{km})$$

with U_o = Operating Voltage (kV)

ω = Angular Frequency

Dielectric power loss factors $\tan \delta$ for typical cable insulations are:

XLPE $(1.5 \text{ to } 3.5) \cdot 10^{-4}$

C = Operating Capacity ($\mu\text{F}/\text{km}$)

II) Current – dependent losses

The current dependent losses consist of the following components:

- Ohmic conductor losses
- Losses through skin effect
- Losses through proximity effect
- Losses in the metal sheath

OHMIC CONDUCTOR LOSSES

The ohmic losses depend on material and temperature. For the calculation of the ohmic losses I^2R , The conductor resistance stated for 20° C (R_o) must be converted to the operating temperature of the cable.

$$R_t = R_o [1 + \alpha(\theta - 20^\circ\text{C})] \quad (\Omega/\text{km})$$

With

$\alpha = 0.0393$ for Copper

$\alpha = 0.0403$ for Aluminium

The conductor cross- section and admissible DC resistances at 20°C (R_o) correspond to the standard series pursuant to IEC 60228/IS:8130.

LOSSES THROUGH SKIN EFFECTS

The losses caused by the skin effect, meaning the displacement of the current against the conductor surface, rise approximately quadratic with the frequency. This effect can be reduced with suitable conductor constructions, e.g. segmented conductors

LOSSES THROUGH PROXIMITY EFFECT

The proximity effect detects the additional losses caused by magnet fields of parallel conductors through eddy currents and current displacement effects in the conductor and cable sheath. In practice, their influence is of less importance, because three conductor cables are only installed up to medium cross sections and single conductor cables with large cross sections with sufficient axis space. The resistance increase through proximity effects relating to the conductor resistance is therefore mainly below 10%

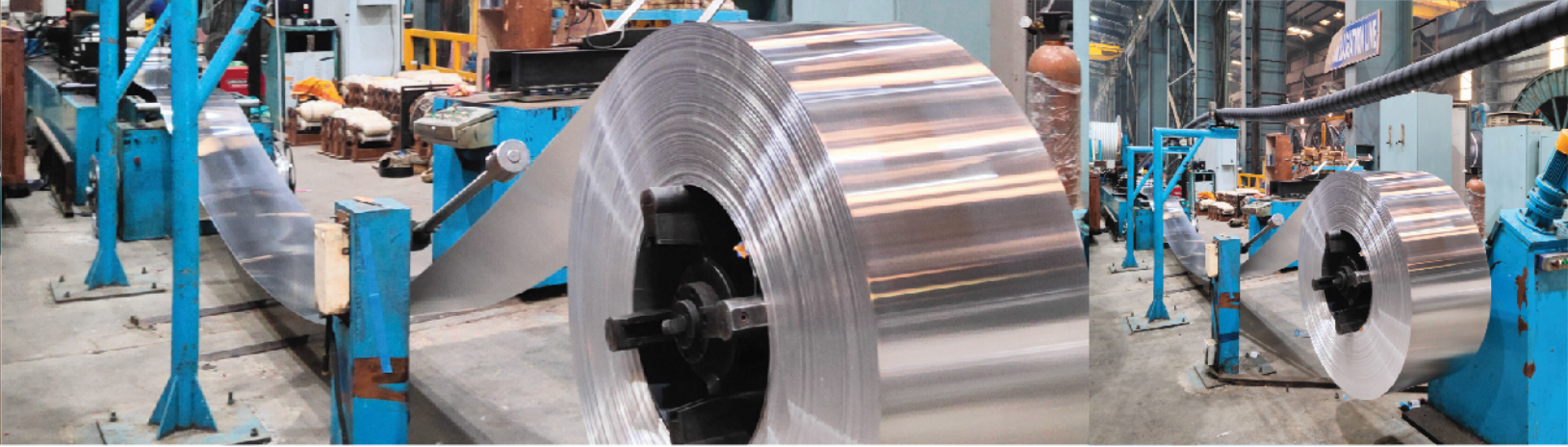

LOSSES IN THE METAL SHEATH

High voltage cables are equipped with metal sheaths or screens that must be earthed adequately. Sheath losses occur through:

- Circulating currents in the system
- Eddy currents in the cable sheath (Only applicable for tubular types)
- Resulting sheath currents caused by induced sheath voltage (in unbalanced earthing systems)

The sheath losses, especially high circulating currents, may substantially reduce the current load capacity under certain circumstances. They can be lowered significantly through special earthing methods

LAYING INFORMATION

Minimum permissible bending radii during laying:

- During pulling of power cables, the bending radii should not be smaller than the recommended values
- In the case of single bends, the values may be reduced to a minimum of 70% if the cables are carefully and evenly bent only once before a termination (around a pre-fabricated bow, if necessary)

Maximum Permissible pulling tensions during laying:

- During laying of power cables attention must be paid to permissible tensile forces

Permissible tensile forces when pulling by cable pulling grip:

$$F = A \times 15 \text{ N/mm}^2$$

(Cable with Al-Conductor)

$$F = A \times 20 \text{ N/mm}^2$$

(Cable with Cu-Conductor)

Maximum value in both cases is 40 KN

Maximum recommended tensile forces when pulling eye is attached to the conductor:

Al-conductor $F = A \times 50 \text{ N/mm}^2$

Cu-conductor $F = A \times 70 \text{ N/mm}^2$

Maximum value in both cases is 80 KN

A = Cross Sectional area of conductor in mm² (without screen and conc. Conductor)

Minimum permissible cable temperature during laying:

XLPE insulated cable U > 30 kV; -5°C for HFFR and PVC-sheath, -15°C for PE-sheath. At lower temperature the cables must be adequately warmed up beforehand. This can be done by storing the cables in heated room for several days or by means of special equipment.



XLPE - INSULATED CABLES DIRECTLY IN GROUND

XLPE-insulated cables can continuously be loaded to a conductor temperature of 90°C in underground installations. If a cable in the ground is continuously operated at this highest rated conductor temperature, the thermal resistivity of the soil surrounding the cable may in the course of time increase from its original value as a result of the drying-out processes. As a consequence, the conductor temperature may greatly exceed the highest rated value. Using single-point bonding or cross bonding instead of both-end bonding results in a considerable increase in the current carrying capacity.

SHORT-CIRCUIT CURRENT CAPACITY

When planning cable installations, care has to be taken that the cables and fittings chosen are capable of withstanding the expected dynamic and thermal short-circuit stresses. The dynamic stresses depend on the max. asymmetric short-circuit current and the thermal stresses on the mean short-circuit current.

DYNAMIC STRESSES

Generally cables and their standard accessories will withstand the dynamic stresses under short-circuit conditions, but near the power stations it is important to take into considerations the dynamic short-circuit current capacity and to pay attention to the technique of installation.

THERMAL STRESSES

On page No. 10, the maximum permissible short-circuit currents for short-circuit duration of one second are given. These values are based on the following presumptions:

- Before short-circuit, the temperature of conductors - maximum permissible temperature of conductor in continuous use
- Maximum permissible temperature of conductor in short-circuit is 250 DegC for XLPE Insulated cables
- The permissible short-circuit currents for short-circuit duration of 0.2 upto 5 seconds may be calculated by multiplying the value of maximum short-circuit current for short-circuit duration of one second by the figure $1/\sqrt{t}$ where t is the duration of short-circuit in seconds

A) Underground installation of EHV XLPE Cables

- 1.1) Bending Radius - The minimum bending radius for EHV XLPE cables is 20 X D, where D is the overall diameter of cable.
- 1.2) Installation in ground - Underground XLPE cables are usually buried directly in the ground.

Single core cables can be laid in flat or trefoil formation as shown in figures.

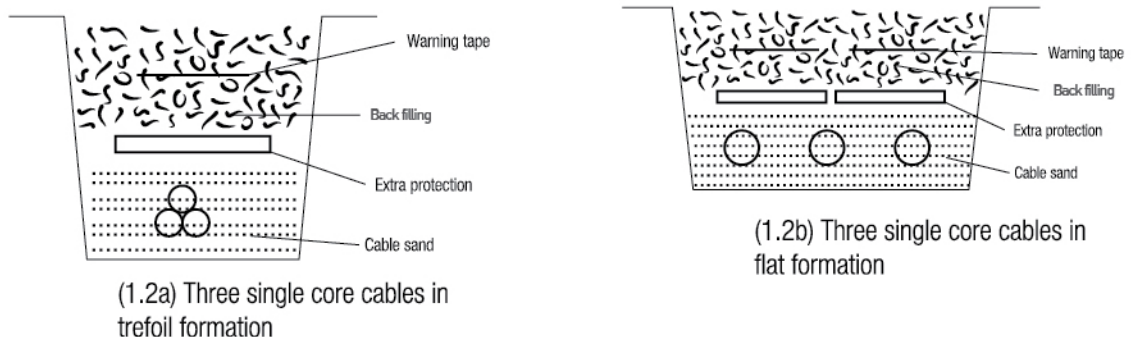

- 1.3) Depth of laying - As a general rule, EHV cables are laid at a depth of 1 to 1.5 m. the laying depth is chosen depending on obstacles in the ground e.g. telephone cables or water pipes. There may be more reasons for deeper laying, which then mean a reduction of current carrying capacity.
- 1.4) Sand bedding - The cable shall be completely surrounded by well-compacted sand to such a thickness and of such a grain size that the cable is completely protected against damage. The thickness of sand bedding should normally be a minimum of 10 cm in directions from the cable surface. Sand with grain size less than 8 mm is considered to give the cable a good protection.

- 1.5) Extra protection - Important feeders and cables at places where extended digging activity is expected can be further protected against damage by means of tubes, slabs, troughs or warning tapes. Ducts of non-magnetic material for single core cables can be mainly used at road crossing etc., the duct diameter should not be less than 1.5 times the cable diameter. In trenches, normally extra protection is obtained by means of concrete slabs and its size is chosen according to the expected damage. The slabs are placed directly on the cable sand.

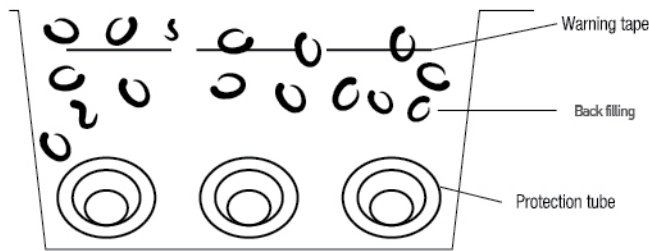

(1.5) Three single core cables in protecting ducts, flat formation

- 1.6) Back filling - Normally, the back fill consists of the material earlier excavated. However, bigger stones or pieces of rock should be removed.
- 1.7) Warning Tape - A pre-warning tape (yellow PVC tape) should be laid in the ground.
- 1.8) Transportation - In order to avoid damage to the cable, the cable drum must be handled carefully during transportation. It is very important that the cable drum stands on the flanges during transportation, well fixed to the transport vehicle. Loading and unloading should be made by crane or fork truck, not by rolling. Rolling of the drum should be done slowly and carefully in the direction of the arrow on the drum.
- 1.9) Cable pulling - During the pulling, the cable drum is normally placed on jacks at the starting point and wire winch at the other end of the trench. The pulling wire can be connected to cable either by a cable stocking or pulling eye to the conductors in such a manner that water or soil cannot enter into the cable.
The maximum pulling force for Aluminium and Copper conductor shall be as follows:
For Cable Stocking 40 KN
For Pulling Eye 80 KN
The cable should preferably be pulled from the top of the drum. To prevent crossing of turns on the drum at sudden pulling stop, a brake should be arranged at the cable drum and a man placed there to operate this brake, which must be pulled rapidly to stop.
To protect the cable from damage during the pulling out, cable rollers should be used and placed at suitable intervals. At bends, angle rollers and guide rollers as required must be used in order to maintain the desired bending radius of the cable. During the cable pulling, telephones or walkie-talkie should be used to ensure the internal communication. Once established, it helps in preventing accidents and enables a safe pulling operation.

B) Installation of XLPE cable in air

The requirement for bending radii, transportation and pulling of the cables are the same as for underground installation. For fixing of the cable, the following requirements have to be taken into consideration:

Cable fixing	After laying of three Nos. cable, the cable shall be tied up with non-magnetic metals trefoil/ single clamp depend up on the laying configuration i.e., Trefoil/flat
Horizontal distance between cleats	At 1 to 1.5 meter interval or as per customer's choice
Vertical distance between cleats	If the cable circuits are laid in tiers then the vertical spacing between the tiers should not be less than 300 mm

SCREEN BONDING METHODS

SOLID BONDING OF SCREENS

Both ends of the cable sheath are connected to the system earth. With this method no standing voltages occur at the cable ends, which make it the most secure regarding safety aspects. On the other hand, circulating currents may flow in the sheath as the loop between the two earthing points is closed through the ground. These circulating currents are proportional to the conductor currents and therefore reduce the cable ampacity significantly making it the most disadvantageous method regarding economic aspects.

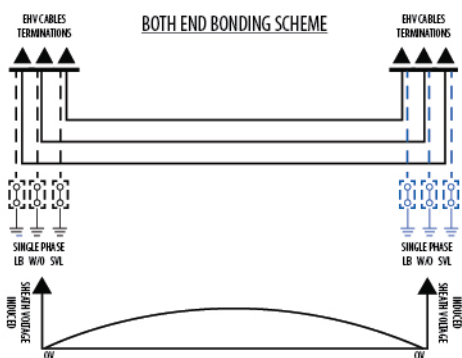

SINGLE-POINT BONDING OF SCREENS

One end of the cable sheath is connected to the system earth, so that at the other end ("open end") the standing voltage appears, which is induced linearly along the cable length. In order to ensure the relevant safety requirements, the "open end" of the cable sheath has to be protected with a surge arrester. In order to avoid potential lifting in case of a failure, both earth points have to be connected additionally with an earth continuity wire. The SVL (sheath voltage limiter) is designed to deflect switching and atmospheric surges but must not trigger in case of a short-circuit.

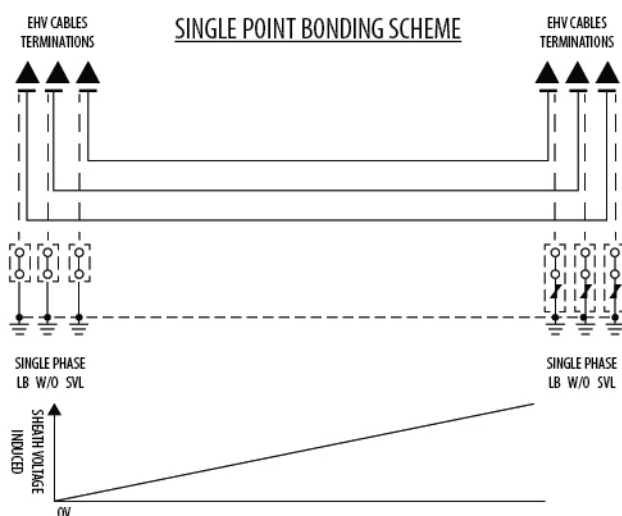

CROSS BONDING OF SCREENS

This earthing method shall be applied for longer route lengths where joints are required due to the limited cable delivery length. A cross-bonding system consists of three equal sections with cyclic sheath crossing after each section. The termination points shall be solidly bonded to earth.

Along each section, a standing voltage is induced. In ideal cross-bonding systems the three section lengths are equal, so that no residual voltage occurs and thus no sheath current flows. The sheath losses can be kept very low with this method impairing the safety as in the two-sided sheath earthing.

Very long route lengths can consist of several cross-bonding systems in a row. In this case, it is recommended to maintain solid bonding of the system ends in order to prevent travelling surges in case of a fault.

In addition to cross-linking the sheaths, the conductor phases can be transposed cyclicly. This solution is especially suited for very long cable lengths or parallel circuits.

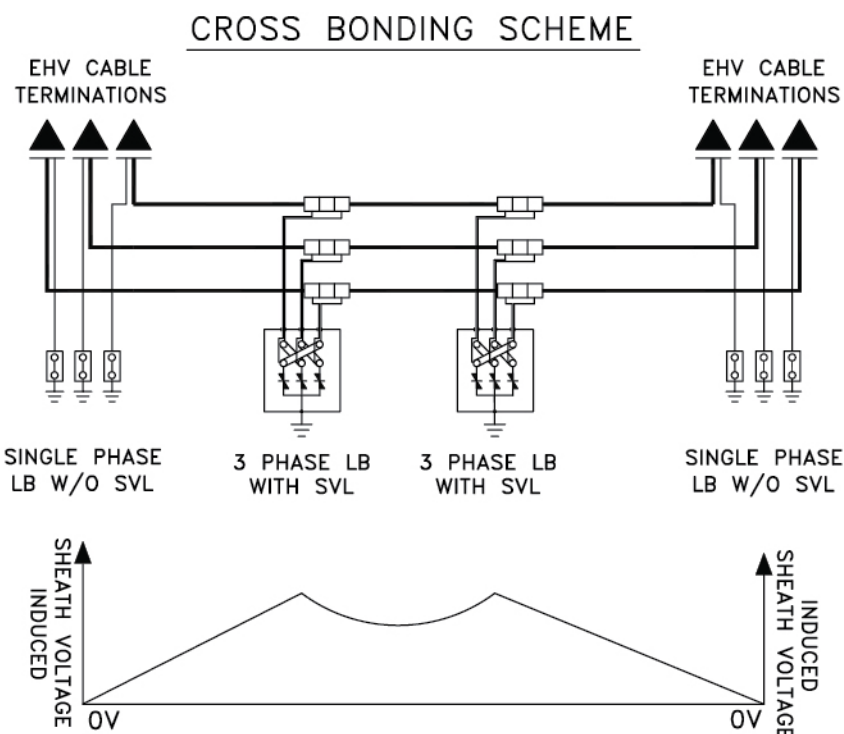

TESTING PROCEDURE AFTER INSTALLATION

(UPTO 400 kV XLPE CABLE)

Tests will be performed according to IEC: 60840, IEC: 62067 and SCECO-E-Specification.

DESCRIPTION OF TEST

REQUIREMENT

1. PHASE CHECKING:

Correct phasing is verified by successively grounding individual phases and checking the corresponding phase at the opposite end using a Megger set at 5kV. The correct phase should be grounded with all other phases showing open circuit.

POSITIVE CONFIRMATION

2. INSULATION RESISTANCE MEASUREMENT:

The Insulation Resistance is measured between the conductor at 5kV DC, and its grounded shield. This test is to be performed both before and after the DC High Voltage Test.

SUITABLE RESISTANCE FOR CABLE AGE.

3. DC SHEATH TEST:

A DC voltage of 10 kV is applied for 1 minute. This test should be performed after initial cable installation with the cable backfilled in the trench (where applicable) and finally when the cable installation is complete. No breakdown should occur.

10kV DC 1 MIN.

4. AC VOLTAGE TEST:

The waveform shall be substantially sinusoidal and the frequency shall be between 20 Hz & 300 Hz. In particular cases, the minimum frequency can be reduced to 10 Hz subject to agreement between the purchaser and the manufacturer. A voltage according to IEC 60840/62067 shall be applied for 1 h, except in cases where this is not practicable.

AC VOLTAGE TEST OF THE INSULATION

5. CAPACITANCE:

Using a digital LCR Meter capacitance is measured between conductor and shield.

MATCHING CABLE DESIGN PARAMETERS

6. CONDUCTOR CONTINUITY AND CONDUCTOR DC RESISTANCE TEST:

With the conductors looped at the remote end, a loop resistance is measured successively between all phases. By simultaneous equations DC resistance for each conductor can be calculated.

MATCHING CABLE DESIGN PARAMETERS

7. CABLE SHIELD CONTINUITY AND CABLE SHIELD DC RESISTANCE TEST:

With the cable shields looped at the remote end, a loop resistance is measured successively between all phases. By simultaneous equations DC resistance for each cable shield can be calculated.

MATCHING CABLE DESIGN PARAMETERS

8. LINKBOX/ JOINTBAY EARTH RESISTANCE TEST:

Using specialized contact resistance test equipment and the 3 point method, the Linkbox Ground Rod network earth resistance is measured.

LESS THAN 20 $\mu\Omega$

9. LINKBOX LINK CONTACT RESISTANCE TEST:

Using specialized contact resistance test equipment (Digital Micro Ohmmeter) the Linkbox Link Contact Resistance is directly measured.

LESS THAN 20 $\mu\Omega$ AT EACH CONNECTION

10. SHEATH VOLTAGE LIMITER (SVL) CHARACTERISTIC CHECK:

SVL DC Voltage withstand test- application of DC voltage to verify SVL design parameters.

SVL design parameters.

SVL Insulation Resistance Check.

MATCHING CABLE DESIGN PARAMETERS



CABLE ACCESSORIES

JOINTS

Joints allow the reliable connection of cables to each other.



Based on excellent experience with joints of our MP family, all main advantages of the pre-tested one-piece SiR slip-on bodies have been kept. As the most crucial element of the joint, design, material selection and production of the insulation body undergoes extensive research at Brugg Cables. As a result, the outstanding properties and long-time stability of the SiR were maintained and the electrical design was optimized.

The insulation body comprises the semiconductive deflectors & middle electrode and the insulation compound. Thanks to a perfect combination of outstanding electrical and mechanical properties and excellent interface behaviour, silicone rubber (SiR) is used for the deflectors, the middle electrode and the insulation. To ensure proper functioning at all voltage loads and to guarantee a long and reliable life, the semiconductive parts are made of solid material. For optimal electrical stress distribution, the insulation body was designed based on computer FEM simulations. The extreme flexibility of the SiR ensures easy and fast assembling. The excellent elasticity of the SiR has an optimised level of surface pressure and ensures void-free contact between the insulation body and the cable. These advantages will remain constant over an extremely long service period. All these features result in a joint that is highly reliable and will last a lifetime. For added quality, the insulation bodies are produced as a single piece, are prefabricated in-house and are pretested in our Swiss production plant.



Maximum operation reliability with a metal radial moisture barrier as standard for all joints.

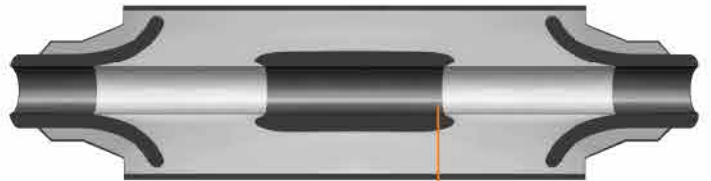

Wide range of application with insulation diameters



Easier installation thanks to smaller dimensions.

ADVANTAGES OF THE PRE-FABRICATED AND PRE-TESTED ONE-PIECE SiR INSULATION BODY:

- Very high breakdown strength of $\uparrow 23$ kV/mm at 50/60 Hz
- Excellent temperature stability of -50 to $+180$ °C
- Very high life exponent of $n \uparrow 40$
- Excellent field grading performance at high frequency load due to semiconductive parts of solid material
- Optimal electrical stress distribution due to computer-assisted FEM-design
- Void-free contact pressure on the cable surface at normal and elevated load conditions with the excellent elasticity of the SiR
- Long lifetime due to excellent mechanical properties of the SiR
- Connection of different types of polymer cables with different insulation diameters possible due to a high elasticity of the SiR slip-on body

EFFECTIVE RESISTANCE

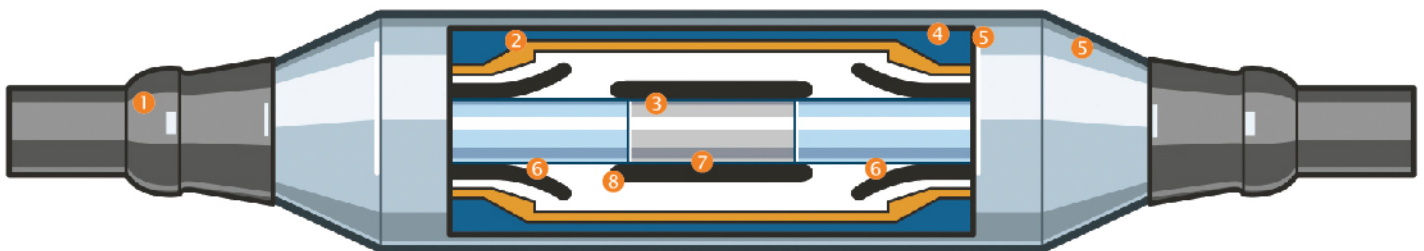

- 1 High voltage polymer cable
- 2 Radial metallic moisture barrier
- 3 Conductor clamp
- 4 Filling material
- 5 Mechanical protection
- 6 Deflector
- 7 SiR slip-on insulation body
- 8 Middle electrode

That you can benefit from the advantages of the new slip-on joints, we offer the products for polymer cables with insulation diameters of 57 to 102 mm and a conductor cross-section of up to 2500 mm². The joints are tested to a service voltage of 145 kV and a BIL level of 650 kV.

By incorporating a radial metallic moisture barrier as standard, the reliability of the joint is even greater. Four different mechanical designs ensure added flexibility in usage and application. Smaller dimensions and a larger diameter range for applications round off the new features. Together with the proven advantages of the SiR slip-on body, you are always well connected with our new joints.



Joint with metal foil and heat shrink cover.

AT A GLANCE, THE MAIN ADVANTAGES OF OUR PRE-TESTED SLIP-ON JOINTS ARE:

- Very compact dimensions
- 100 % failure free pre-tested one-piece SiR slip-on bodies
- Total moisture barrier provided by a radial metallic shield as a standard
- No preload during transport or storage
- Possibility to use different types of outer mechanical protection designs
- Easy to handle and install thanks to a longer middle electrode and exceptional elasticity, no high mechanical forces needed for installation
- Possible to apply coaxial cross-bonding cables up to a cross-section of 500/500 mm²
- Many uses in all environments, laying conditions and climates

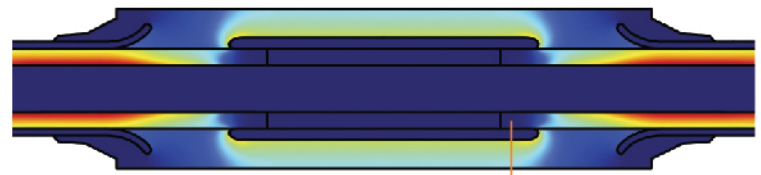

Simulations:
Design based on computer FEM-simulations for optimal electrical stress.

Brugg Cables is devoted to the quality, performance and reliability of its products. High standards in production and testing are the order of the day at our factory in Switzerland. Computerised machines and skilled personnel are the guarantee for our high quality. To ensure this, each insulation body is tested individually. Of course, all our joints are suitable for any type of polymer cable or cable manufacturer.

Earthing. Earthing can be made according to customer specifications. All joints are designed in a way that are either direct earthing, straight through connection or through where cross-bonding is possible. Cross-bonding cables can be applied up to 500/500 mm².

High quality in production. Consistent, high quality standards in manufacturing are guaranteed by using computerised machines. To ensure 0-failure during production, each part is tested several times in the manufacturing process. Every device is certified individually.

Standards. All joints are designed according to international standards, such as IEC 60840 or IEEE 404-2000. As a matter of course, we are certified according to ISO 9001 and ISO 14001.

Testing. To guarantee the quality of our products, testing is essential. All equipment is tested extensively in R&D. Our products are type-tested according to IEC 60840 and IEEE 404-2000. To ensure that all slip-on bodies are 100 % working, they all have to pass a routine test in accordance with IEC 60840.

Installation. To ensure highest quality in the field, we have an own installation department. Brugg engineers operate around the world, erecting and commissioning our various products. In order that you benefit as much as possible, we offer a complete installation service, training for your teams or the supervision of the installation by our experts, all at a reasonable price.



Joint with Cu and FRP protection box.

TERMINATIONS

Terminations allow the reliable connection between a cable and other equipment.

Product Portfolio of EHV Terminations

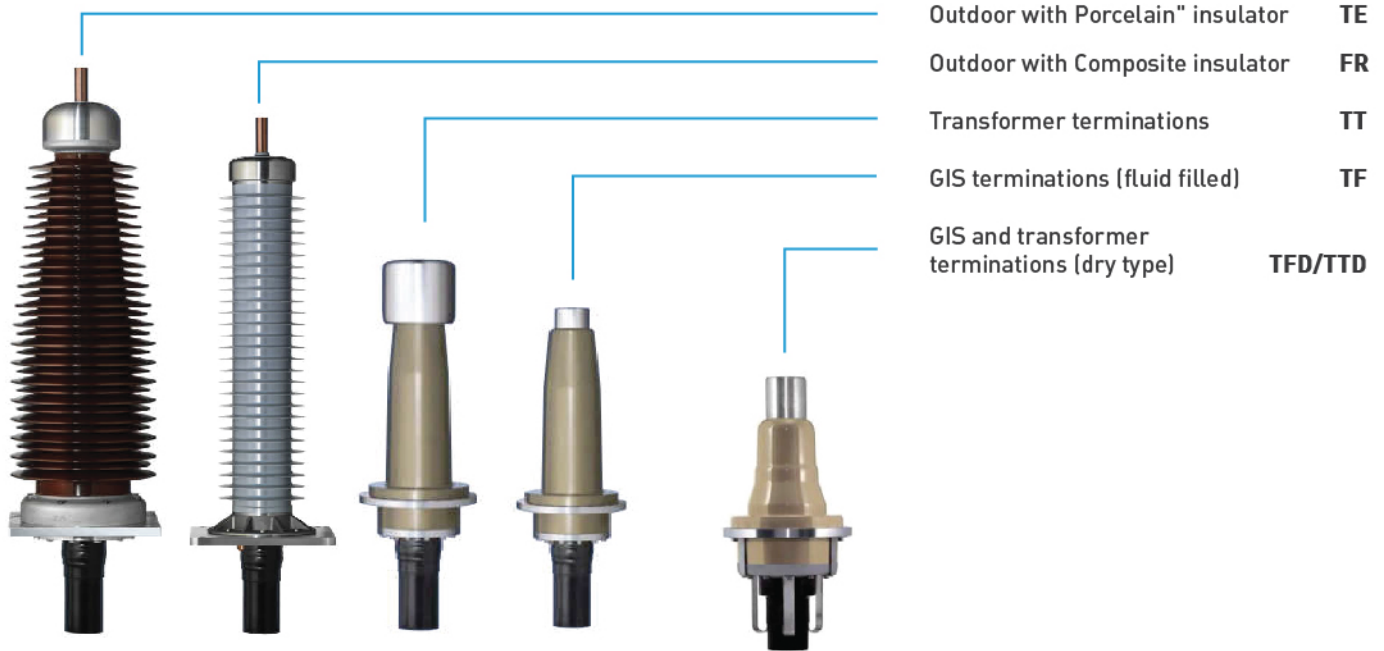

Outdoor terminations - Main components

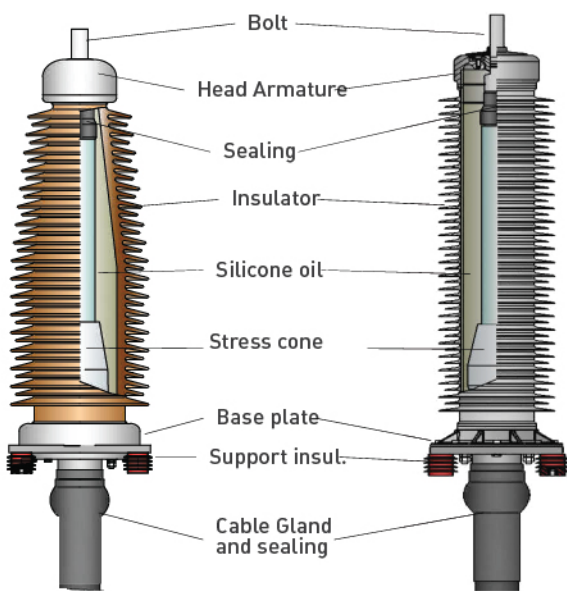

- Bolt** : Conduit the main cable current. Made of Cu or Al. Dimensions according to customer needs: 35-40-50-60 mm
- Head Armature**: Improve the potential distribution along the insulators. For EHV with additional corona ring possible
- Sealing** : Avoid oil ingress into the cable. Improve electrical field
- Insulator** : gives necessary creepage distance and mechanical strength (self supported construction)
- Stress cone**: For electrical field control at the cut edge of cable semicon. Size according to cable dimensions and voltage level
- Silicone oil** : Give additional insulation. Works as filling media between cable and insulator inside the termination.
- Base plate** : For fixing the cable termination to a structure. Typically fixed with Support insulators to isolate from the structure
- Gland** : To fix the cable jacket and screen to the termination. Include a sealing area to avoid water ingress

GIS and Transformer terminations – Main components

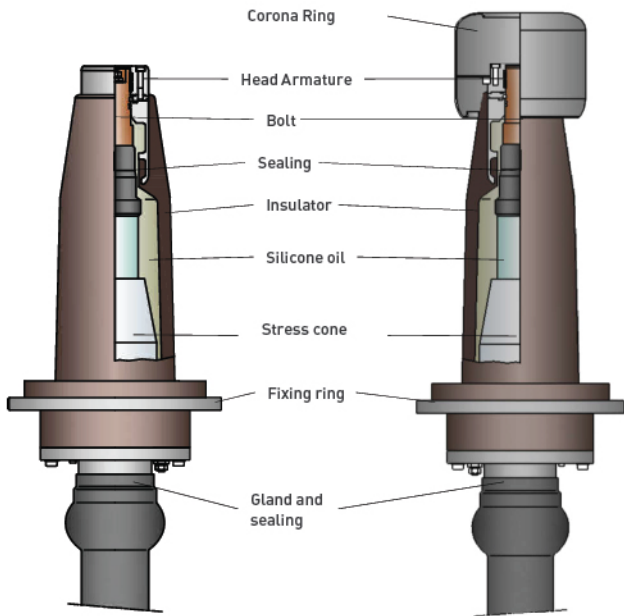

- Bolt:** conduit the cable conductor current
- Head Armature:** Allow interconnection between termination and equipment.
- Sealing :** Avoids oil ingress into the cable. Improves the electrical field
- Insulator:** Works as oil barrier between cable and equipment Outer Dimensions acc. IEC 62271-209
- Stress cone:** for electrical field control at the cable semicon cut edge. Sizes depend on cable dimensions and voltage level
- Silicone oil:** Insulating filling media between cable and insulator
- Spannring:** For fixing the insulator to the equipment. Two possibilities single phase of three phase arrangement
- Cable gland:** For fixing the cable jacket and cable screen. Includes a sealing area to avoid water ingress
- Corona Ring:** to improve electrical field distribution inside transformers. Dimensions according to EN 50299-1

GIS/Transformer plug in terminations type TFD

Dry type plug-in terminatons For polymeric cables up to 550 kV

Dry type plug-in terminations offer highest quality and application flexibility as GIS or Transformer cable termination for system voltages up to 550 kV. Based on the outstanding properties of the prefabricated and electrically tested slip on stress cones, the reliable modular construction of the TFD terminations allow its application to all types of polymeric insulated cables.

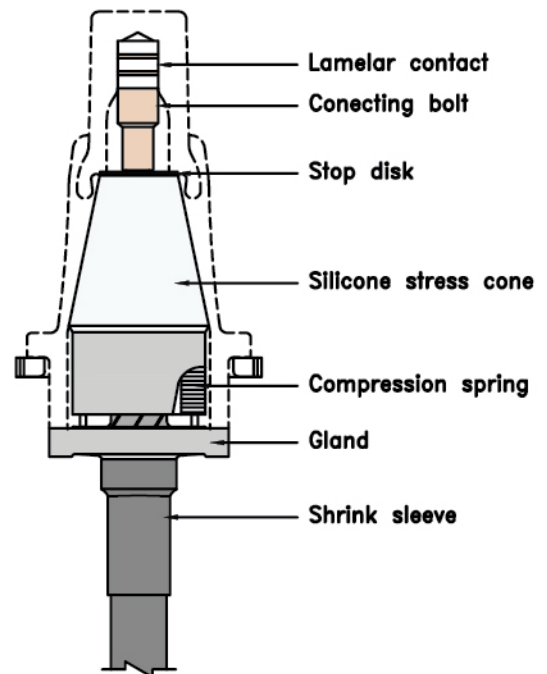

GIS Sockets type TFD

Sockets up to 550 kV

Dry type sockets offer high flexibility to SF6 insulated switchgears for system voltages up to 550 kV. Regardless of whether the required dimensions of the cable compartment are for a dry type or a fluid filled type termination as per IEC 62271 209, each socket is provided with all necessary elements for the fast and easy installation to any switchgear independently of the manufacturer. All materials used are UV and corrosion resistant thus allowing the terminations to be applicable for both indoors and outdoors installations.

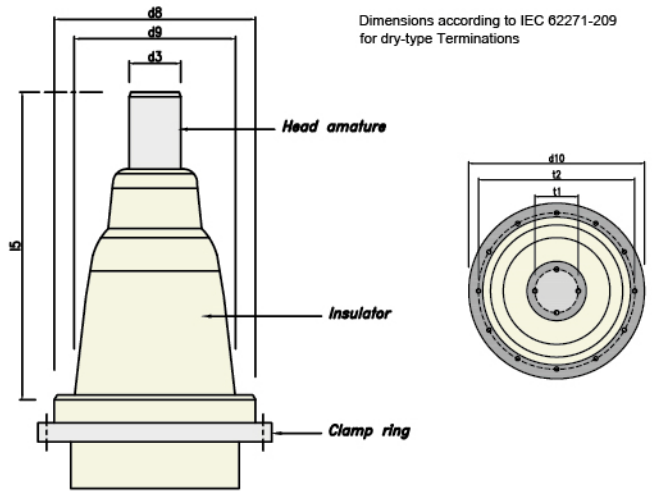

Transformer Sockets type TTD

Sockets up to 550 kV

Dry type sockets offer high flexibility to oil insulated transformers for system voltages up to 550 kV. Regardless of whether the required dimensions of the cable compartment are for dry type terminations according to EN 50299 2 or fluid filled terminations according to EN 50299 1, each socket is provided with all necessary elements for the fast and easy installation to any transformer independently of the manufacturer. All materials used are UV and corrosion resistant thus allowing the terminations to be applicable for both indoors and outdoors installations.

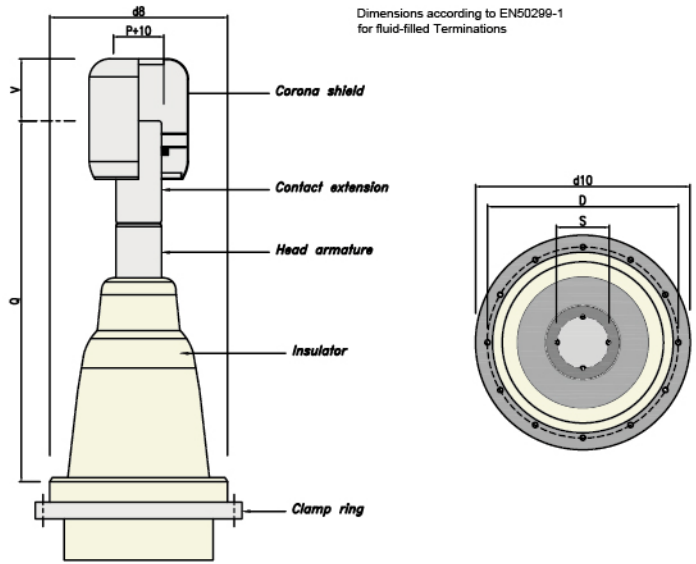

World class Quality, Incredible Range. Wires and cables Specialist.



EHV Cables



HV Cables



LV Cables



House Wires



Stainless Steel Wire

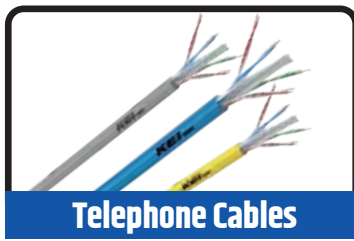

Telephone Cables



Rubber Cables



Control Cables

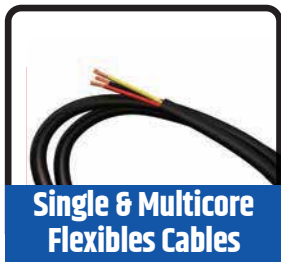

**Single & Multicore
Flexibles Cables**



**EV Charging
Cable & Gun**



**Marine &
Offshore Cables**

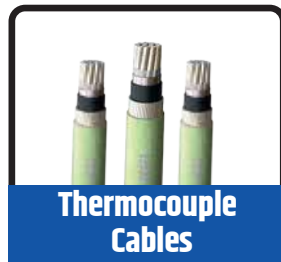

**Thermocouple
Cables**



**Fire Survival
Resistant Cables**

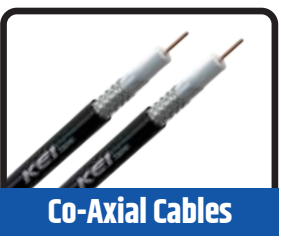

Co-Axial Cables

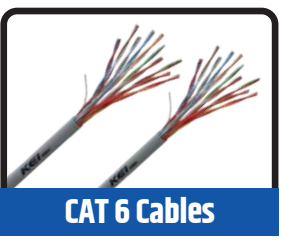

CAT 6 Cables



Solar Cables

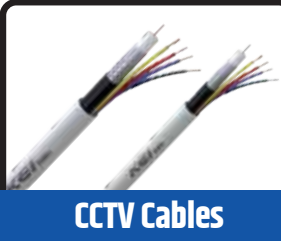

CCTV Cables



**Instrumentation
Cables**



Winding Wires



MVCC Cables

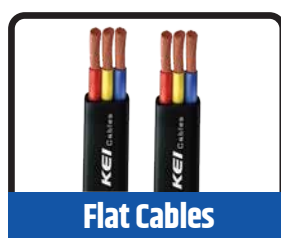

Flat Cables

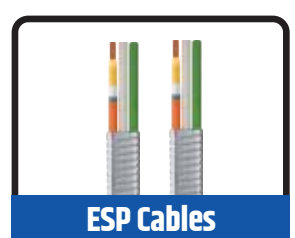

ESP Cables

WIDEST RANGE OF WIRES AND CABLES FROM 1.1KV UP TO 400KV



KEI[®]

Wires & Cables

BRIDGING THE GAP ACROSS 60 DIFFERENT COUNTRIES



THE POWER BEHIND THE POWER



Scan to reach other offices



P: 1300 780 831 E: info@cablegrid.com.au W: www.cablegrid.com.au

KEI Industries Limited

REGISTERED AND CORPORATE OFFICE:

D-90, OKHLA INDUSTRIAL AREA PHASE-I, NEW DELHI-110020, TEL: +91-11-26818840/8642/0242 FAX: 26817225, 26811959
E-MAIL: info@kei-ind.com WEBSITE: www.kei-ind.com CIN NO: L74899DL1992PLC051527

